



TAUMONA

YOUR KITCHEN
FURNITURE RECIPE

WWW.TAUMONA.COM



CONTENTS

ABOUT US.....	4
SUSTAINABILITY.....	8
COLLECTIONS.....	10
PLENUS.....	12
MONS.....	17
ADAMO.....	20
TEMPUS.....	23
FLUCTUS.....	26
CIRRUS.....	29
LINEA.....	31
ISLAND TYPES.....	34
TV UNITS.....	37
BATHROOM FURNITURE.....	40
WARDROBES.....	47
WARDROBE COMBINATIONS.....	53
WARDROBE ACCESSORIES.....	55
COLORS AND DECOR.....	58
WORKTOPS.....	63
FURNITURE FITTINGS.....	67
WASTE SORTING SYSTEMS.....	71
HANDLES.....	73
HANDLES FOR HIGH UNITS.....	74
KITCHEN MODULES.....	75
WORK & LEARN SPACES.....	85
WARDROBE MODULES.....	89
BATHROOM FURNITURE MODULES.....	93
CONTACTS.....	96







T A U M O N A

Your Kitchen Furniture Recipe



Taumona is a family business built on a love of living spaces and a commitment to genuine quality. For years, we have grown together with our clients, creating interiors designed for everyday comfort and lasting satisfaction.



Today, Taumona represents trust, responsibility, and professionalism. Every kitchen and every piece of furniture we produce is carefully crafted with attention to detail and respect for the people who will use it.



Taumona is more than furniture — it is the confidence that your home is thoughtfully designed and made to suit your life.

We design and manufacture bespoke furniture with care and precision — values that guide our work every day and make premium quality attainable.



Why Clients Choose Us?

Bespoke without the luxury price

Customization and efficiency don't usually go together. We have organized our production so custom solutions remain affordable — not just standard options.

Made for designers and convenient for clients

Architects value our flexibility and technical possibilities. Clients appreciate that thoughtful design stays within budget.

Freedom of design

We do not limit projects to catalog dimensions — furniture adapts to the space, not the other way around.

Engineered precision

Behind every project is structured planning, calculation, and over 30 years of manufacturing experience.

Reliable quality

Certified materials and controlled processes ensure furniture that lasts and performs every day.

Predictable production time

We schedule production precisely — your furniture is ready exactly when promised.





SUSTAINABILITY

At TAUMONA, we take sustainable action in the furniture industry not only because we care about the planet's future, but also because we believe our clients value sustainability when making purchasing decisions.

They are increasingly choosing furniture made and packaged with environmentally friendly materials.



We strive to be a sustainable business — through our choice of materials, manufacturing processes, and design approach.

- We are an **FSC® (FSC® C142758)** certified company, ensuring the responsible use of wood.
- All our products meet the strictest EU environmental standards.
- We minimize waste by optimizing material use and promoting the principles of the circular economy.
- We also offer certified, eco-friendly materials carrying **The Nordic Swan Ecolabel**.



Circular Economy

Long-lasting design based on our modular system
Use of solar energy
Responsible waste management



Solar Energy

We prioritize sustainability by using solar energy in our production processes — reducing our carbon footprint and supporting renewable energy initiatives.



Responsible Waste Management

Production waste is sorted and sent for recycling.
All furniture is packaged in easily recyclable materials, allowing for responsible waste sorting.



KITCHEN COLLECTIONS







PLENUS COLLECTION

Clean lines and a carefully selected range of materials and handles allow the design to move from natural warmth to industrial modern. Whatever the interior, PLENUS adapts effortlessly to the space.

Created for those who understand quiet luxury — calm, balanced, and free from unnecessary decoration.











MONS COLLECTION

Refined luxury in a balance of modern and classic design. Clean architectural lines create a calm, organized kitchen space.

The precise 90° milled edge adds subtle elegance, creating a kitchen made for everyday living — long-lasting, timeless, and easy to enjoy for years to come.







Signature 45° detail

ADAMO COLLECTION

For those who dream of ultimate comfort and a truly cozy interior. Soft classic lines and a subtle inward 45° detail on the fronts create a warm, welcoming atmosphere, whether in a countryside villa or a city apartment.

Timeless design made to feel like home — calm, comfortable, and inviting every day.







TEMPUS COLLECTION

Customers appreciate the modern design, distinctive handle, and comfortable feel. Every detail is crafted with care to ensure both beauty and ease of use.

A perfect balance of style, comfort, and functionality — creating a kitchen that feels enjoyable every day.





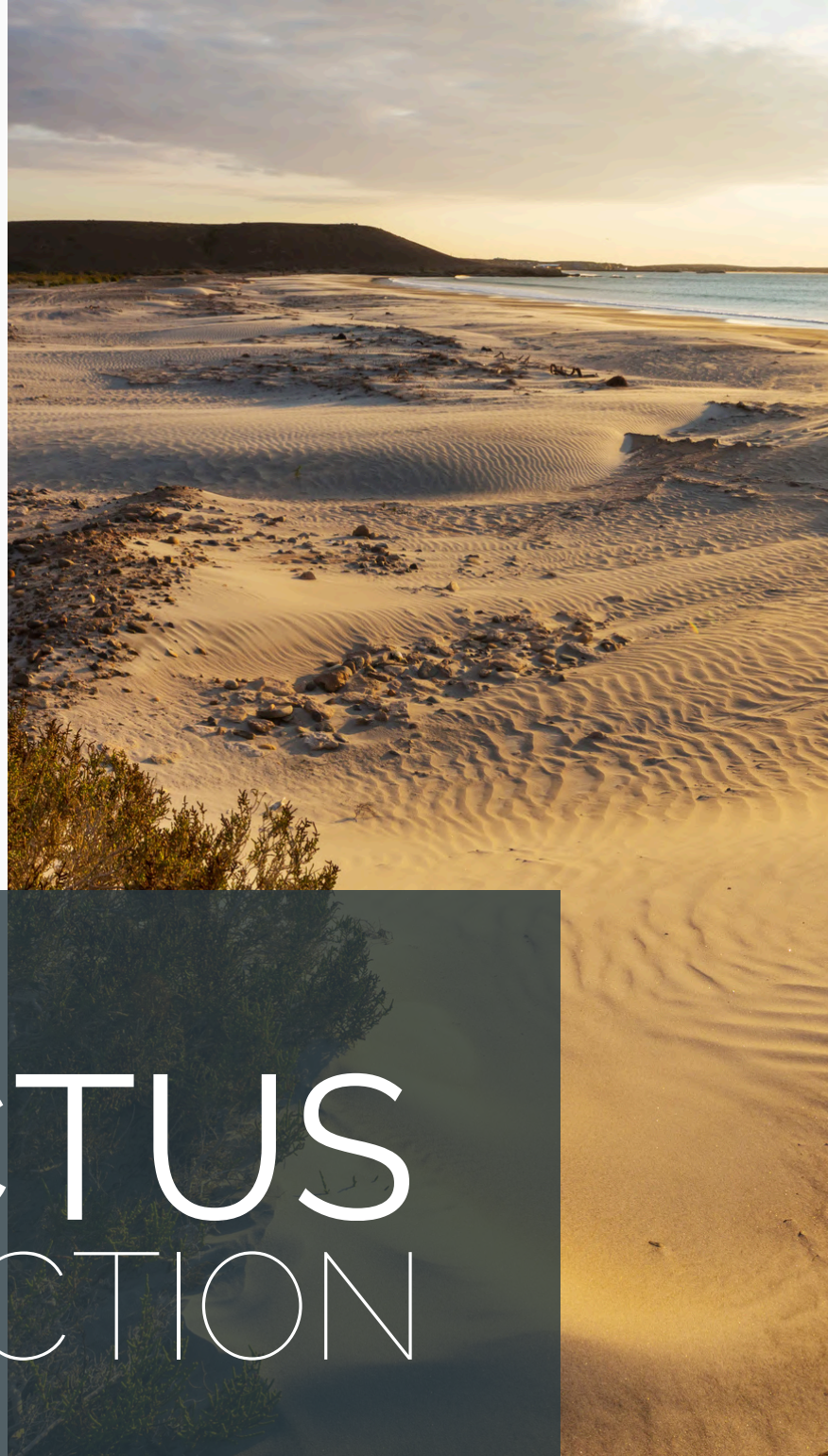

FLUCTUS COLLECTION

Inspired by the calm rhythm of the Baltic Sea. Soft surfaces, natural tones and gentle textures create a space that feels like a quiet morning by the shore — light, peaceful, and unhurried.

Designed for those who feel at home near nature — where the air is soft, the mood is calm, and everyday moments carry the warmth of the seaside.







CIRRUS COLLECTION

Modern and architectural in character. Clean lines and a refined groove pattern shape a kitchen made for deep, dark interiors and a rich, composed atmosphere.

Created for a confident, uncompromising personality — one that values solidity, maturity, and quiet luxury over excess. A space with presence, depth, and intention.

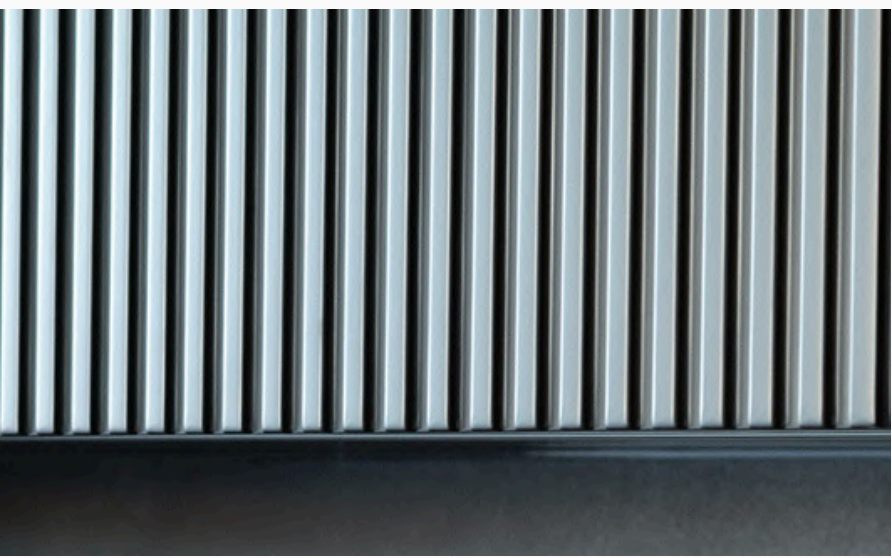



LINEA COLLECTION

Linea is a luxurious collection created for those seeking elegance and exclusivity. Its front frame is milled at a 90-degree angle, giving the design a clean, subtle, and aesthetically refined appearance.





KITCHEN ISLANDS





KITCHEN ISLAND TYPES



A TYPE



B TYPE



C TYPE



D TYPE



TV UNITS COMBINATIONS





BATHROOM FURNITURE















WARDROBES





FUNCTIONAL AND COMFORTABLE CUSTOM WARDROBES

Each wardrobe is carefully designed to match individual needs and space dimensions.

The custom construction allows every centimeter to be used efficiently, creating a functional, spacious, and visually appealing solution.

We offer a wide selection of materials:

- MFC
- MDF
- Milled surfaces
- Natural oak veneer
- Glass

Various design options:

- Wardrobes for walk-in closets
- Hinged doors
- With or without mirrors

Our design team ensures that each wardrobe integrates seamlessly into any interior concept — whether classic, modern, or minimalist.

A wide range of finishes, colors, and front patterns allows full design flexibility to meet every project's requirements and client preferences.

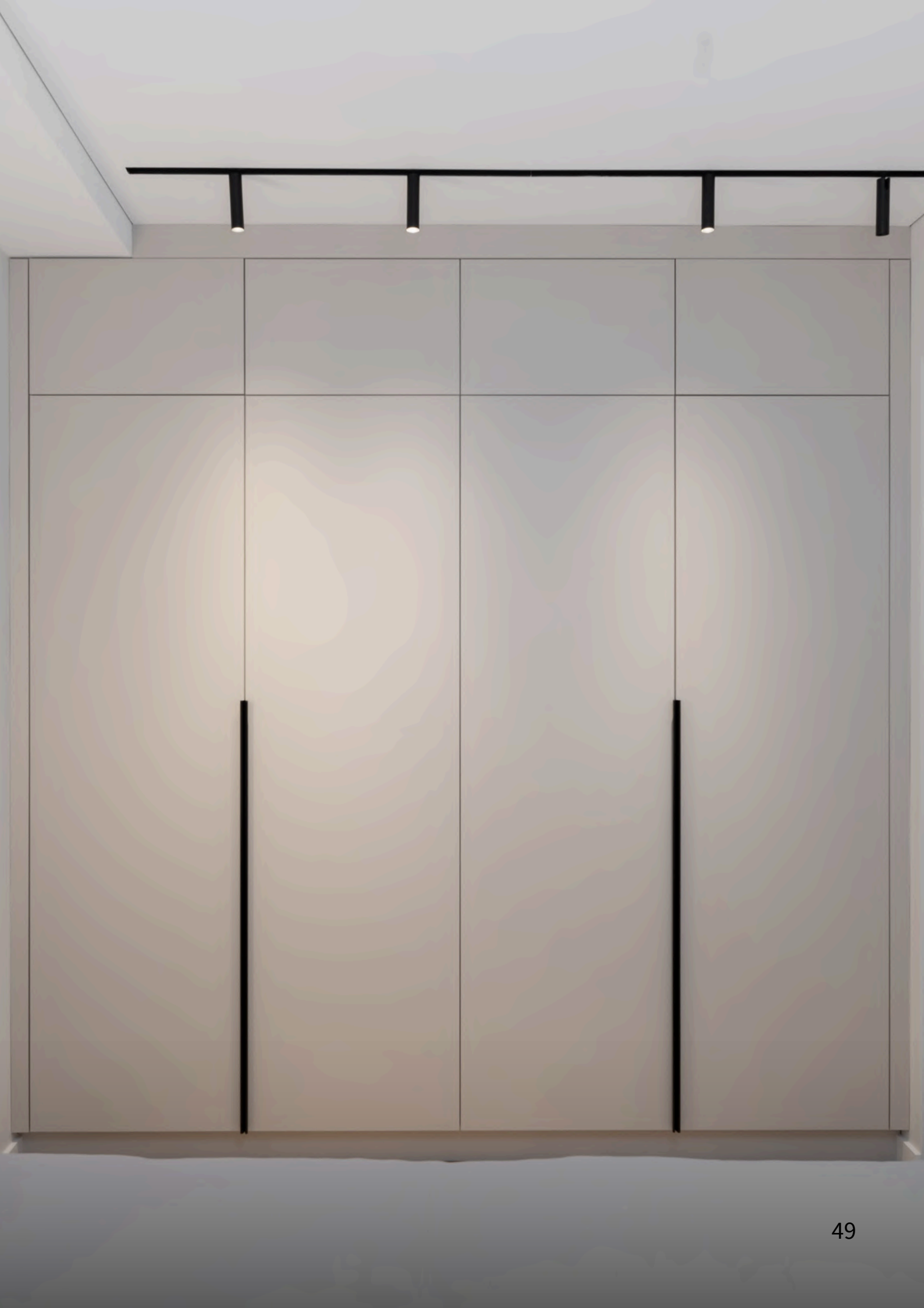







WARDROBE COMBINATIONS





WARDROBE ACCESSORIES





Jewellery and accessory tray inserts

Practical compartments for jewellery and small accessories.



Sliding wire storage drawers

Easy access storage for clothes and everyday items.



Pull-out shoe drawer

Available in 600–900 mm widths for organized footwear storage.



Pull-out trouser holder

Keeps garments neat, visible, and ready to wear. ⁵⁶



Pull-out tie holder

Keeps ties visible and neatly arranged.



Sliding shoe rack

Integrated storage for easy access footwear organization.



Integrated sliding mirror

Ideal for compact wardrobe spaces.



Built-in laundry basket

Discreet and practical laundry storage.



COLORS & MATERIALS

Every interior begins with a feeling. From quiet natural warmth to deep modern tones — the surfaces shape the mood of your home.

Soft woods, calm mattes and expressive textures create a space that reflects how you want to live: calm, bold, cozy or minimal. Simply choose what feels right.

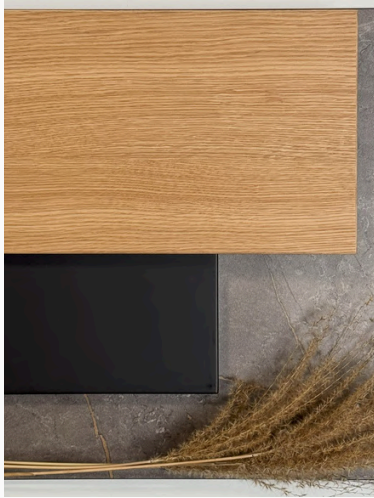

PAINTED MDF FACADE COLORS

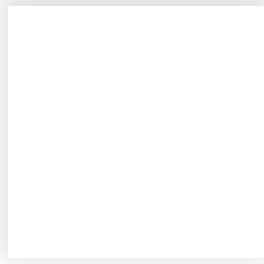

50R2



51R2



52R2



54R2



55R2



58R2

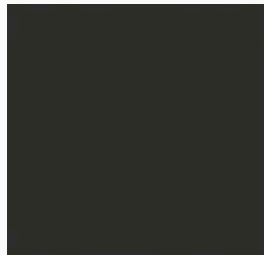

60R2



56R2

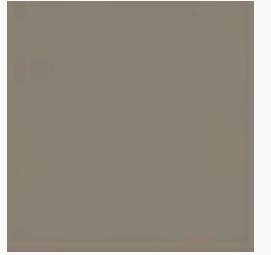

63R2



61R2

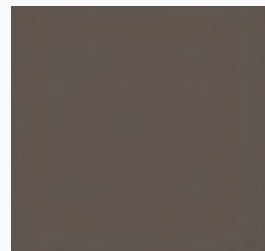

62R2



64R2

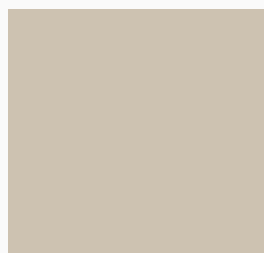

66R2

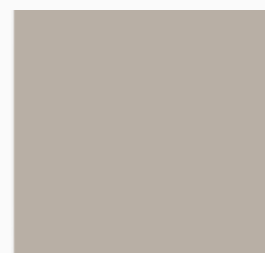

67R2



65R2



69R2

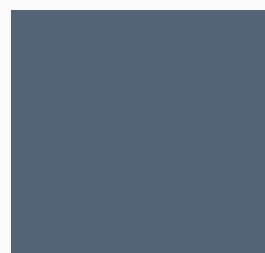

68R2

59



VENEERED



8080

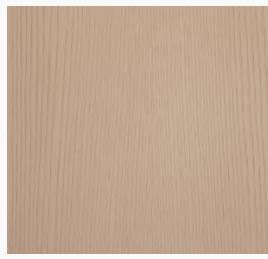

8280

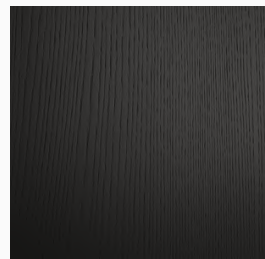

8480



8180



8380



8580

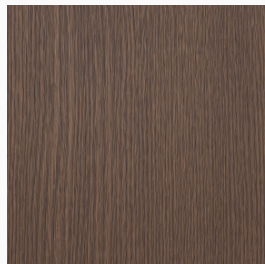

8680



8780



8880



MFC FACADE COLORS

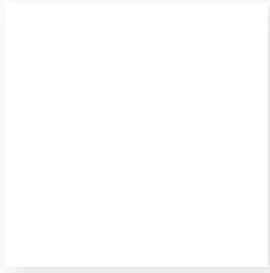

4311



7474



7575



7373



2020



3333



3535



4444

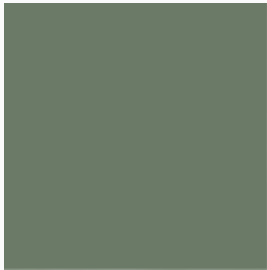

4545



1818

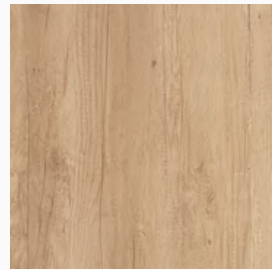

3838



3231



6218

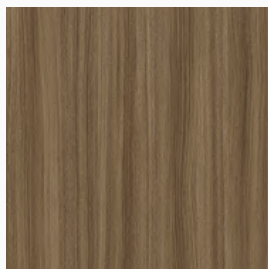

6969

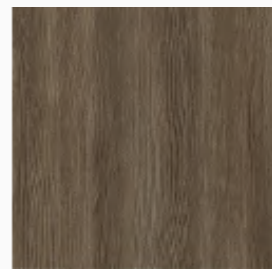

6060



6161



7070

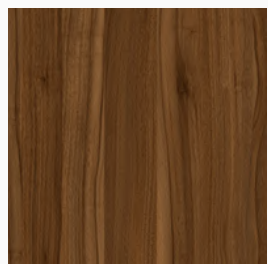

4040

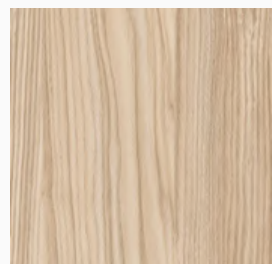

6363



6464 61



6565

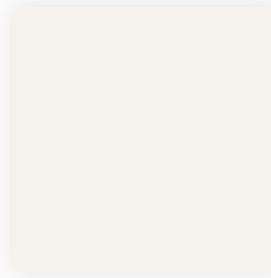

1111



1212

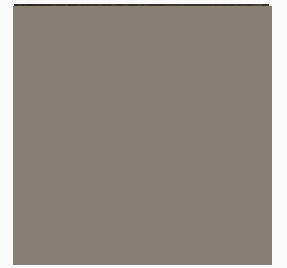

2121

LAMINATED MDF

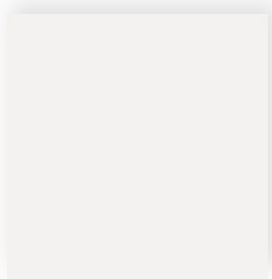

7129



7272



4848

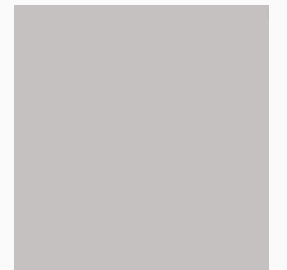

4949



5050

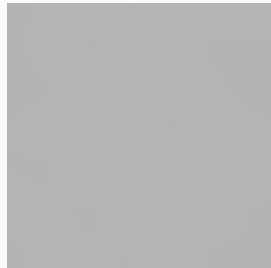

4747



5252



5353

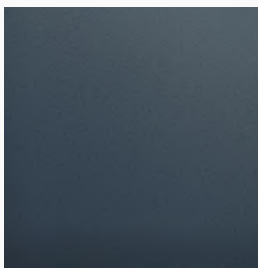

5454

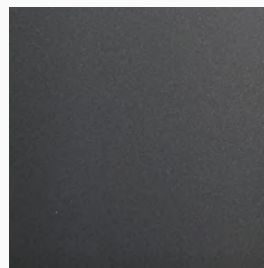

5555

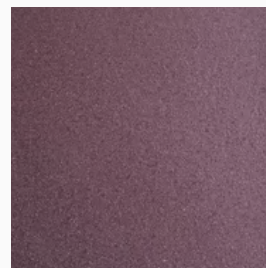

5656

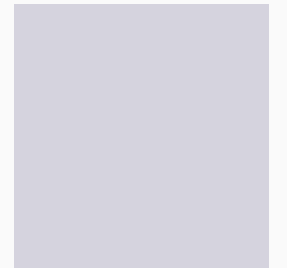

4646

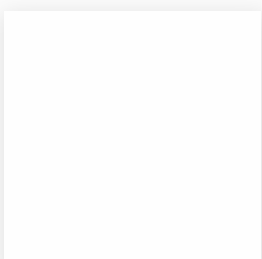

3030 gloss



COMPACT HPL WORKTOPS



C31

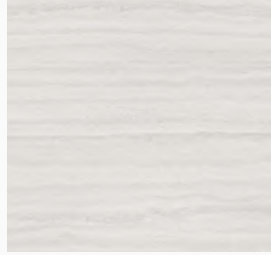

C33

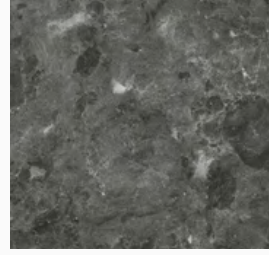

C34

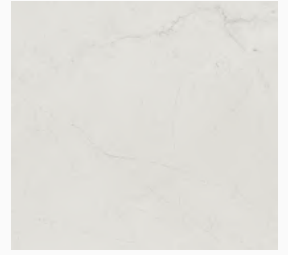

C35



C36



C37



C38



C39



C25



C26

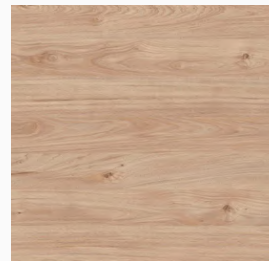

C27



C29



C30

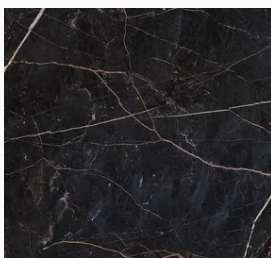

C22

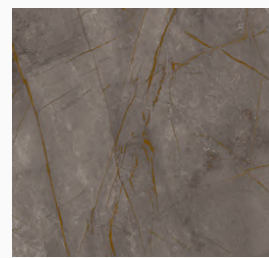

C23



C24

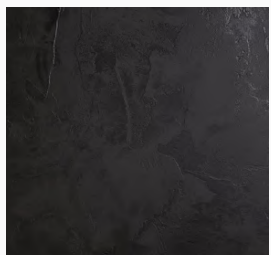

C21



C20

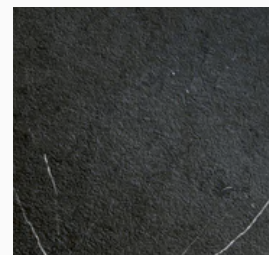

C19



C18 64

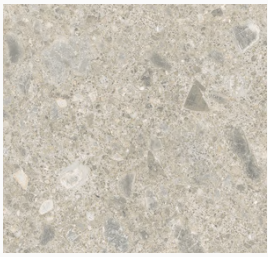

C13

19 MM AND 33 MM HPL WORKTOPS

Worktop labeling: 19 mm – letter H, 33 mm – letter G.



H28/G28

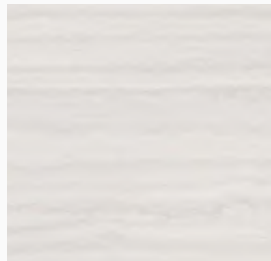

H30/G30

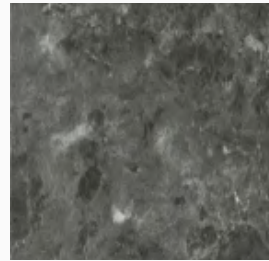

H31/G31

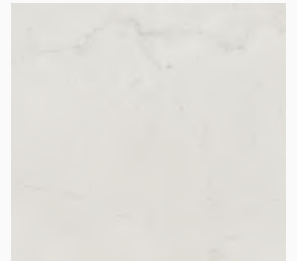

H32/G32



H33/G33



H34/G34

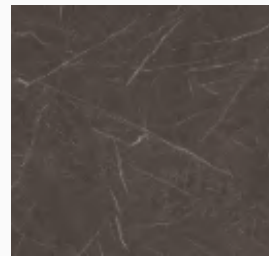

H35/G35



H36/G36

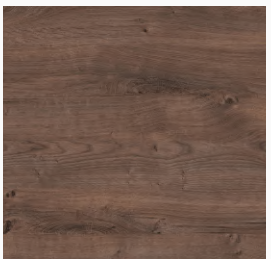

H07/G07



H08/G08



H09

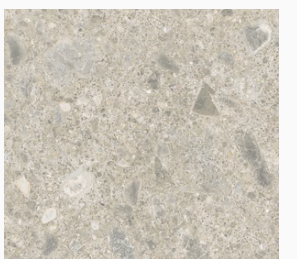

H10/G10



H15/G15

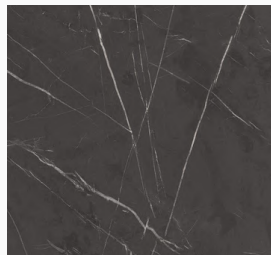

H16/G16



H17/G17



H18/G18₆₅

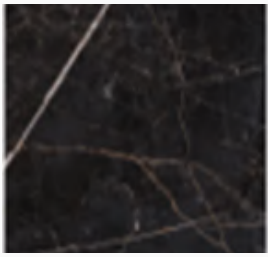

H19/G19



H20/G20



H21/G21



H22/G22



H23/G23



H24/G24



H26/G26

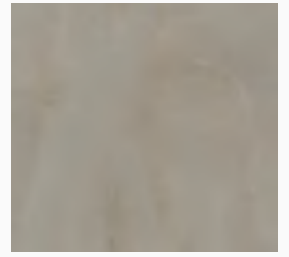

H27/G27

38 MM LAMINATED HPL WORKTOPS



T10

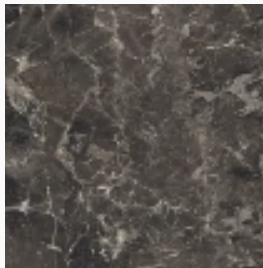

T21

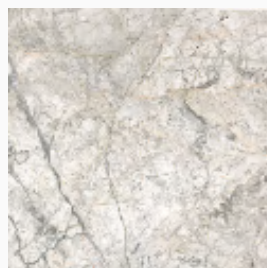

T23



T25



T26



T27



FURNITURE FITTINGS



PREMIUM LINE



FLEX LINE CUTLERY TRAY

Width: 500-600-700-800-900-1000 mm



FLEX LINE CUTLERY TRAY WITH SPICE CONTAINERS

Width: 500-600-700-800-900-1000-1200 mm



MODULAR CUTLERY TRAY BLUM AMBIA LINE

Width: 700-800-900-1000 mm

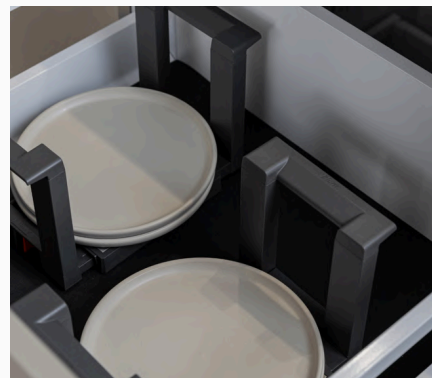
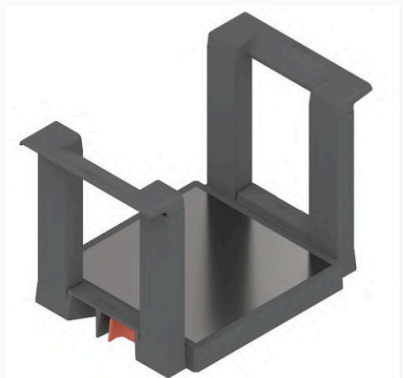

BLUM DISH ORGANIZER

Height: 170 mm

ECO LINE



STANDARD TOOL BOX

Width: 300-400-450-500-600-700-800



EMUCA PLATE HOLDERS

Convenient bowl holders that can be adapted to drawer

LEMANS SYSTEMS



LEMANS ARENA STYLE

Width: 450-500-600 mm

CARGO SYSTEMS



FULL-HEIGHT CARGO
Height: 1600x2000 mm



LOW-PROFILE CARGO
Width: 200-300-400 mm

PANTRY STORAGE SYSTEMS



PANTRY STORAGE
Height: 1700 mm



WASTE SORTING SYSTEMS

TAUMONA

71

PREMIUM



WASTE SORTING SYSTEM CARGO SYNCHRO PREMIUM

Easy to maintain, easy to clean, wide colour selection, high quality.

Width: 450-600 mm

Waste bins: 2-3

FREESTANDING WASTE BINS



WASTE SORTING SYSTEM TANDEM STANDART

Freestanding waste-sorting bins for cabinet installation.

Width: 300-400-450-500-600-800-900 mm

Waste bins: 2



WASTE SORTING SYSTEM ECO

Freestanding waste sorting bins for installation inside a cabinet.

Width: 600-800 mm

Waste bins: 2-3

HANDLES



G-10



G-08



G-09



G-50



G-57



G-59



G-11



G-04



G-87



G-36/G-37



G-32



G-88



G-30



G-16



G-01



G-68/ G-69



G-71/ G-72



G-74/ G-75



G-76/ G-77



G-78/ G-79



G-80/G-81

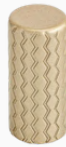

G-83



G-84/G-85



G-42/G-43
G-44



G-39



G-60



G-62



G-64



G-23/G-24



G-20/G-21



G-66

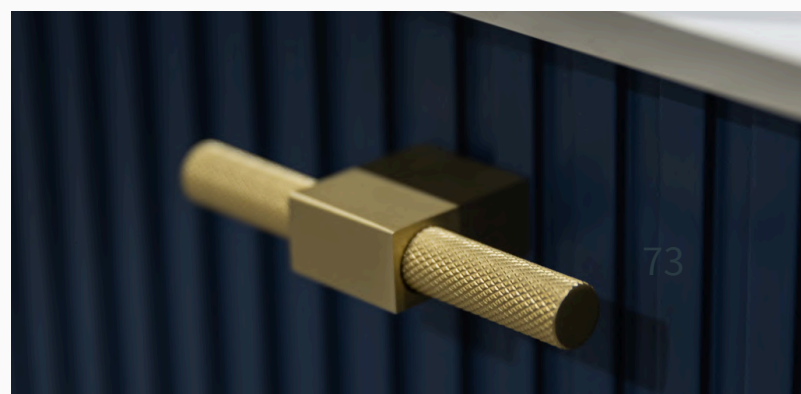

HANDLES FOR HIGH UNITS



G-32

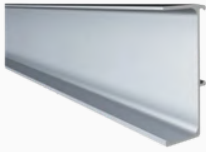

G-88



G-30



G-45



G-58



G-61

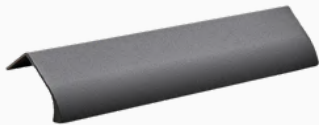

G-63



G-65



G-67



G-22

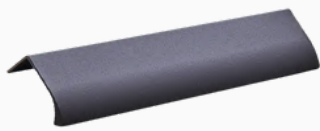

G-25



G-82



G-86



G-40



G-38



G-73



G-70



OUR KITCHEN MODULES

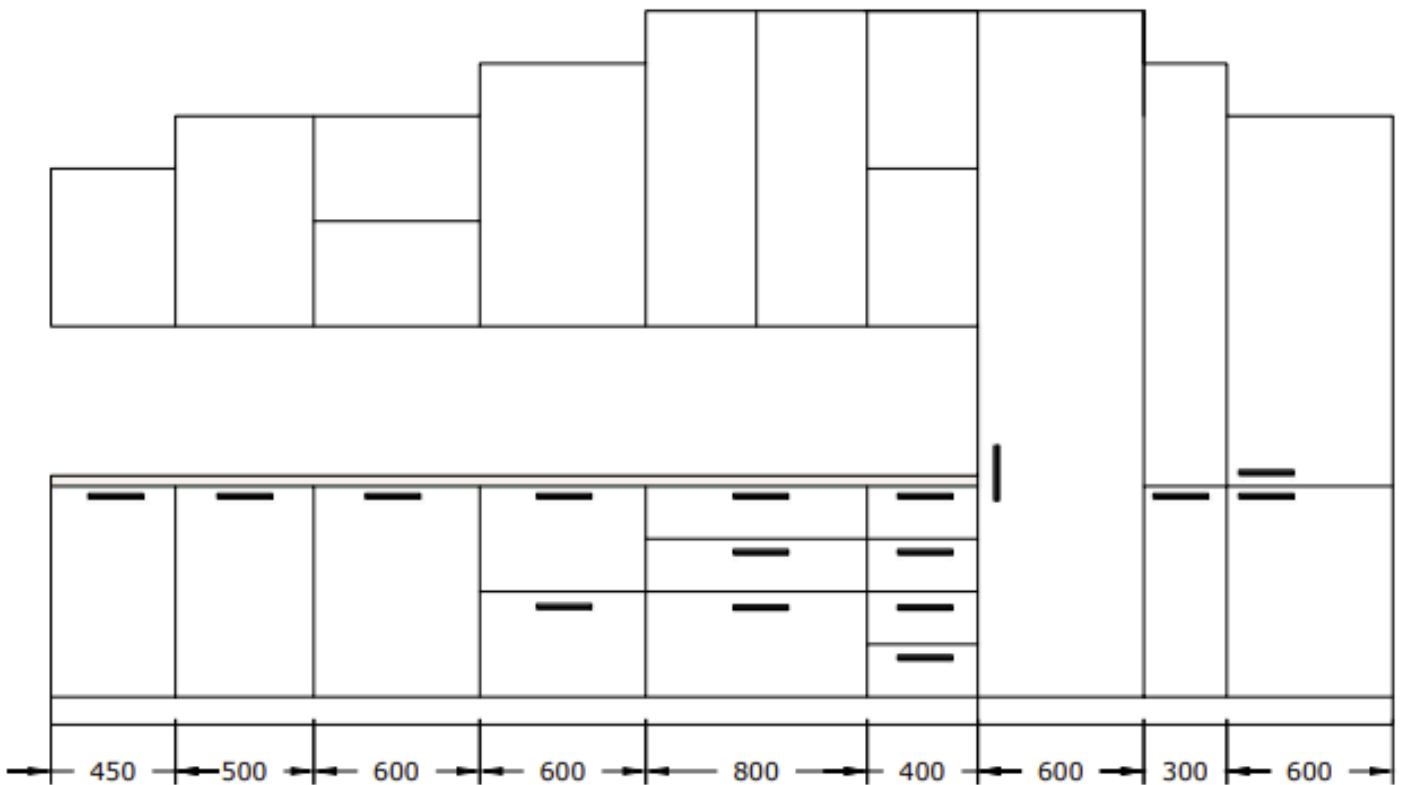

WITHOUT AN UPPER CABINET

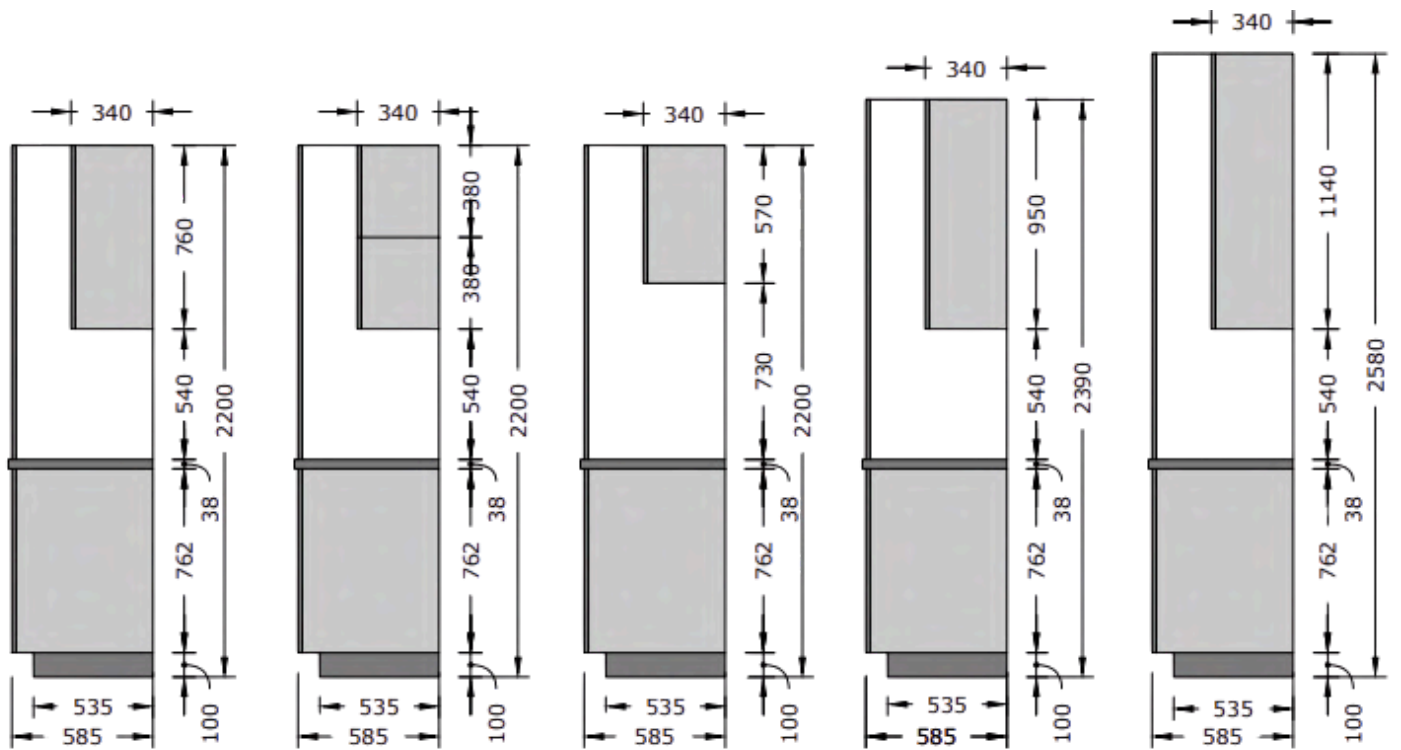

WITH AN UPPER CABINET

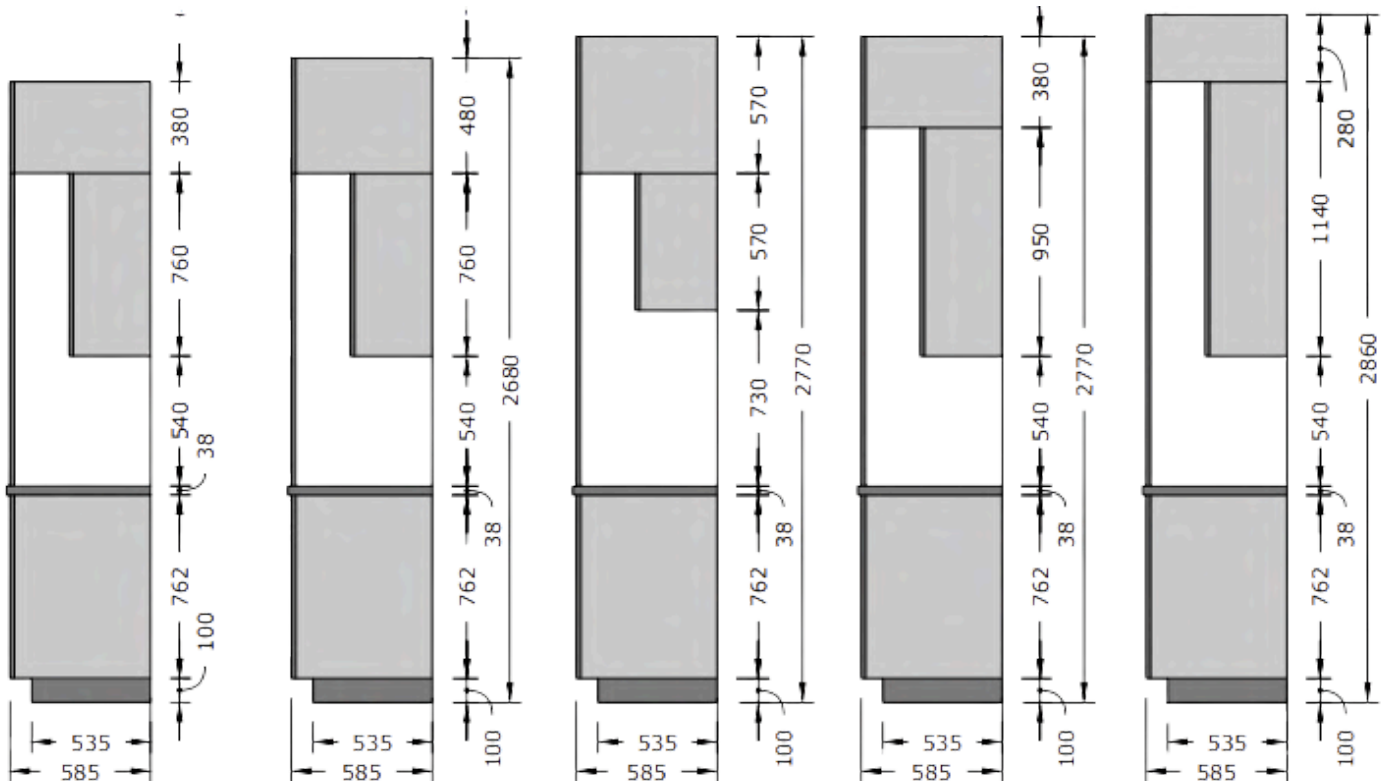

BASE CABINETS

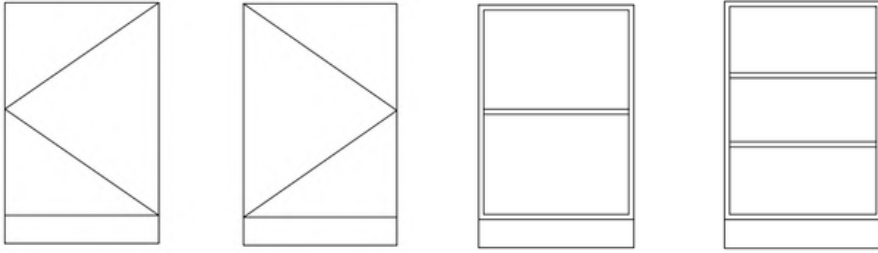

WITH SINGLE DOORS / **WIDTH:** 200;300;400;500;600 mm / **DEPTH:** 300;585 mm



WITH DOUBLE DOORS / **WIDTH:** 600;800;900;1000 mm

WITH SINGLE DOOR / **WIDTH:** 500;600 mm / **DEPTH:** 300;585 mm

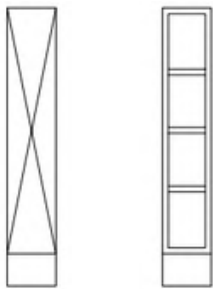

CARGO / **WIDTH:** 150;200;300;400 mm
OPEN SHELVES / **WIDTH:** 150;200 mm

BASE CABINETS WITH DRAWERS

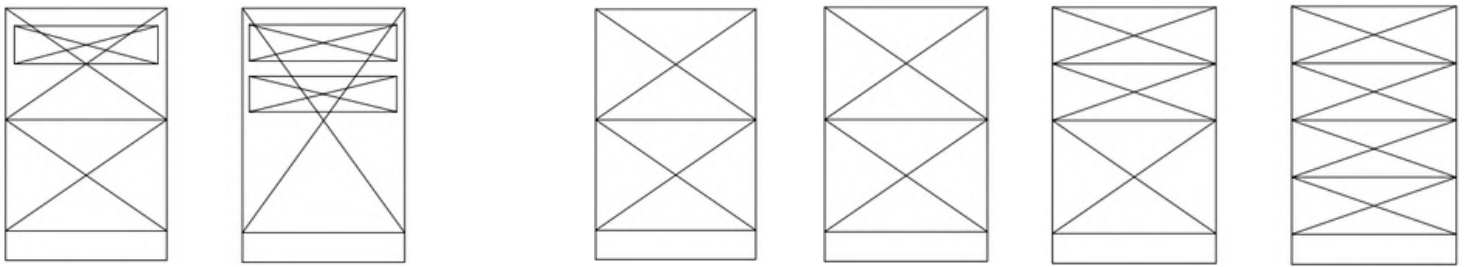

WIDTH: 500;600;700;800;900;1000 mm

WIDTH: 300;400;450;500;600;700;800;900;1000 mm

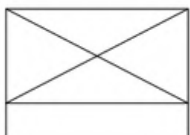

WIDTH: 600mm
HEIGHT: 380mm

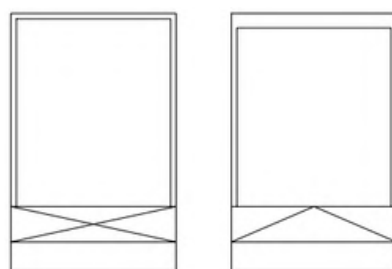

FOR OVEN/ **WIDTH:** 600mm

BASE CABINETS FOR SINKS

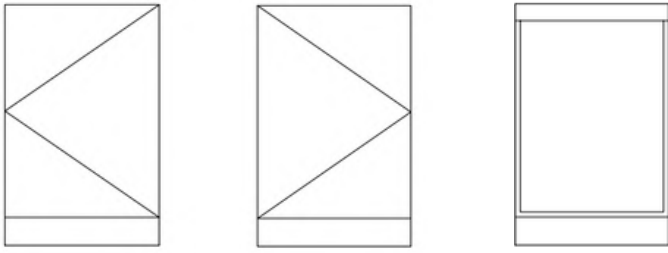

WITH SINGLE DOORS / **WIDTH:** 450;500;600 mm

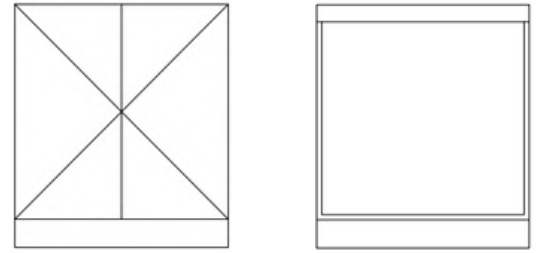

WITH DOUBLE DOORS / **WIDTH:** 600;800;900;1000 mm

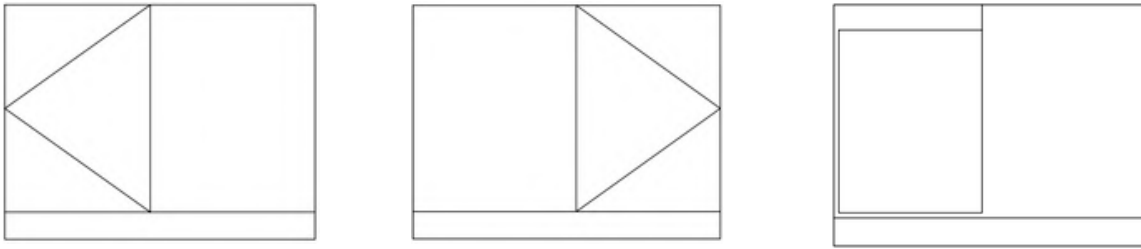

CORNER CABINET WITH DOORS / **WIDTH:** 500;600 mm

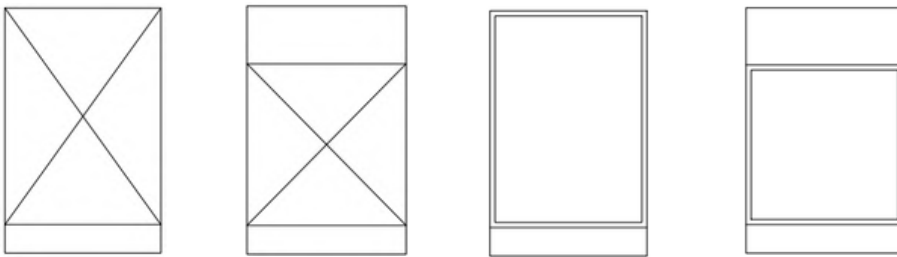

WITH LARGE DRAWER / **WIDTH:** 450;600;800 mm

BASE CORNER CABINETS

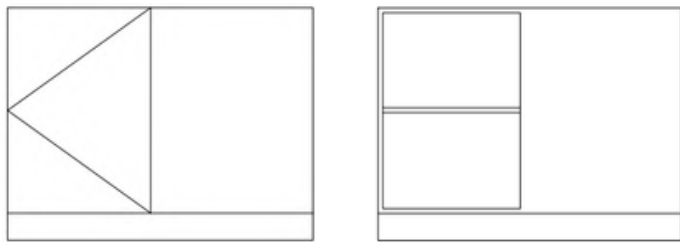

WITH SINGLE DOOR / **WIDTH:** 300;400;450;500;600 mm

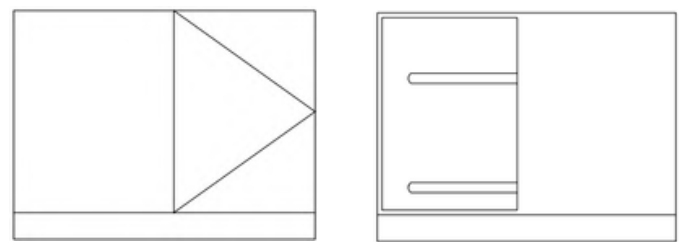

WITH SINGLE DOOR AND CORNER SYSTEM / **WIDTH:** 450;500;600 mm

WALL CABINETS

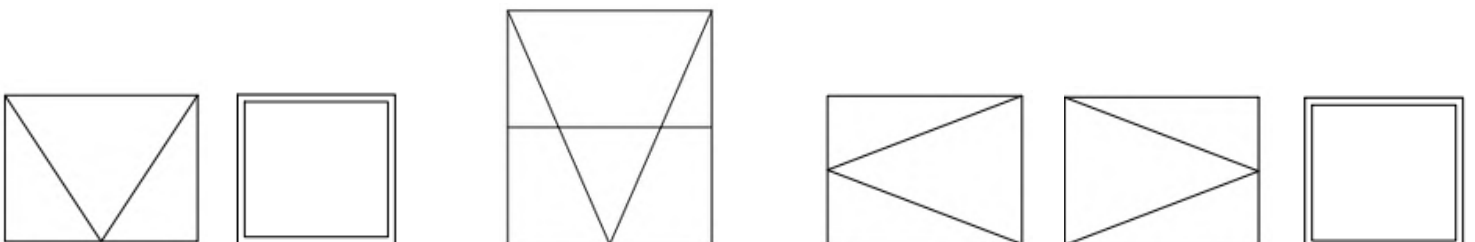

HEIGHT: 380 mm / **WIDTH:** 400;450;500; 600;
700;800;900;1000 mm

HEIGHT: 760;950;1140 mm
WIDTH: 600;700;800;900;1000 mm

HEIGHT: 380 mm **WIDTH:** 400;450;500;600 mm

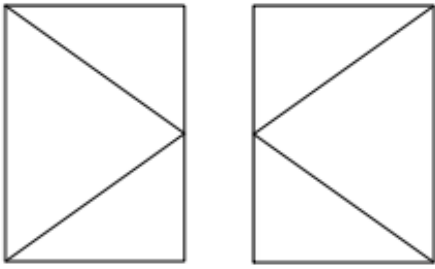

HEIGHT: 570;760;950;1140 mm
OPEN SHELVES: 200;300;400;450;500; 600 mm



CABINET WITH OPEN SHELVES
HEIGHT: 570; 760;950;1140 mm
WIDTH: 200;300;400;450;500; 600 mm

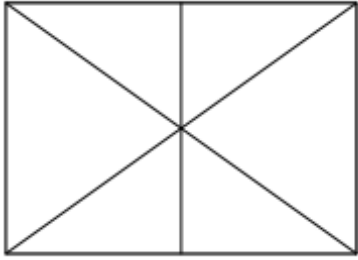

HEIGHT: 570;760; 950;1140 mm
WIDTH: 700;800 mm

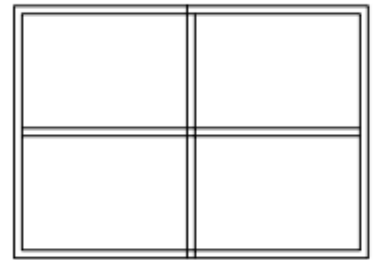

WIDTH: 900;1000 mm / **HEIGHT:** 570;760; 950;1140 mm

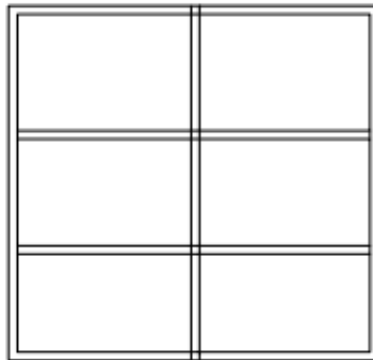
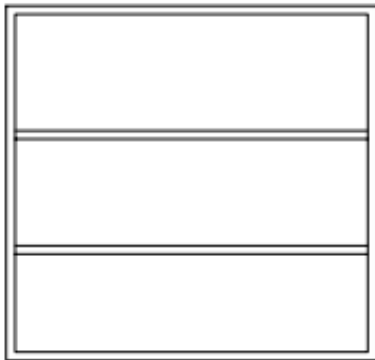

WIDTH: 900;1000 mm / **HEIGHT:** 570;760; 950;1140 mm

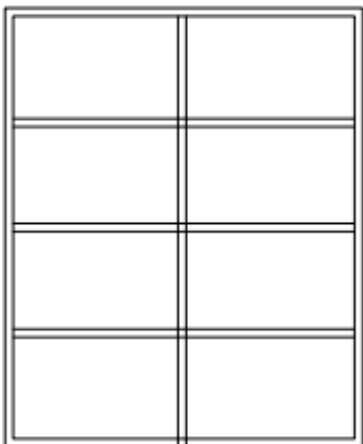

WIDTH: 900;1000 mm
HEIGHT: 570;760; 950;1140 mm

WALL CORNER CABINETS

HEIGHT: 380; 570; 760; 950; 1140 mm / WIDTH: 300; 400; 450; 500; 600 mm

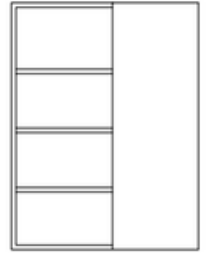
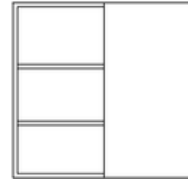
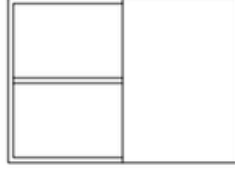
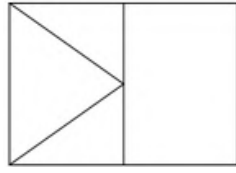
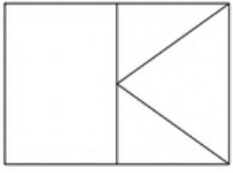

WALL CABINETS FOR APPLIANCES

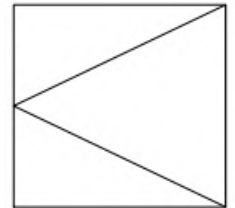
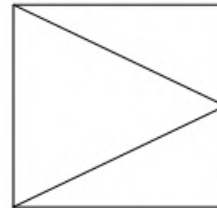
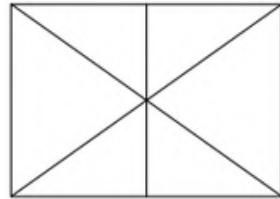
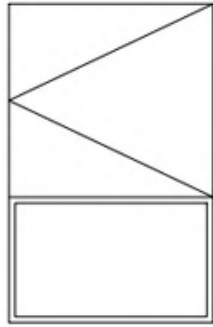
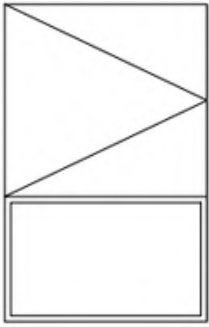

HEIGHT: 760; 950; 1140 mm / WIDTH: 600 mm

HEIGHT: 570; 760; 950; 1140 mm
WIDTH: 700; 800 mm

HEIGHT: 570; 760; 950; 1140 mm / WIDTH: 600 mm

TOP CABINETS

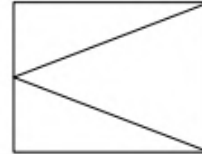
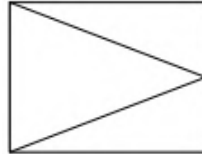
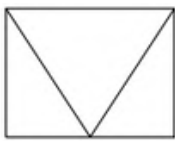

HEIGHT: 280; 380; 480 mm / WIDTH: 300; 400; 450; 500 mm

HEIGHT: 380 mm / WIDTH: 300; 400; 450; 500; 600 mm

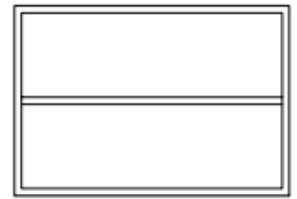
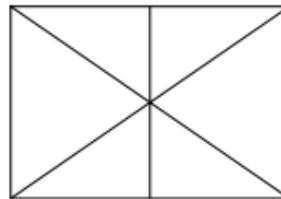
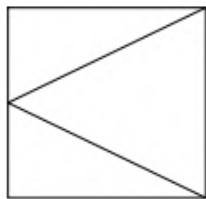
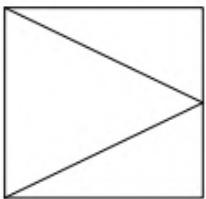

HEIGHT: 480; 570 mm / WIDTH: 300; 400; 450; 500; 600 mm

HEIGHT: 480; 570 mm / WIDTH: 700; 800 mm

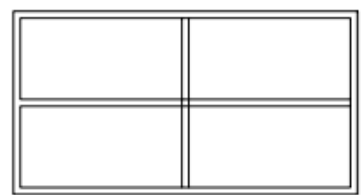
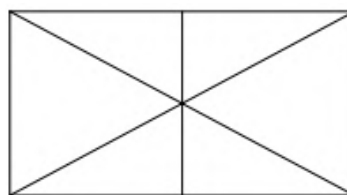

HEIGHT: 380 mm / WIDTH: 700; 800 mm

HEIGHT: 480; 570 mm / WIDTH: 900; 1000; 1200 mm

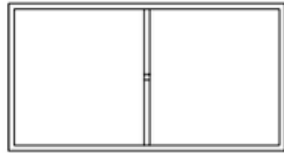
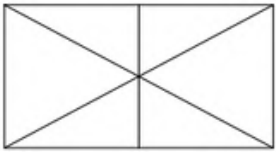

HEIGHT: 380 mm / **WIDTH:** 900;1000;1200 mm

FULL-DEPTH WALL CORNER CABINETS

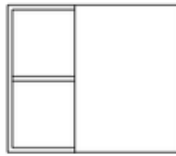
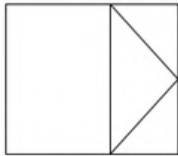
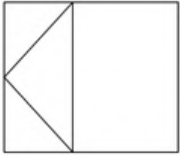

HEIGHT: 380;570;760;950;1140 mm / **WIDTH:** 260 (600) mm / **DEPTH:** 585 mm

WALL CABINETS FOR COFFEE MACHINE

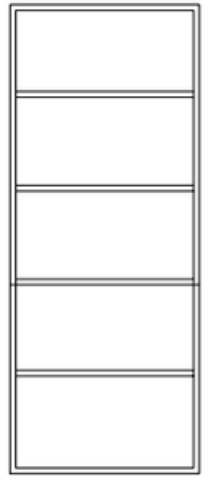
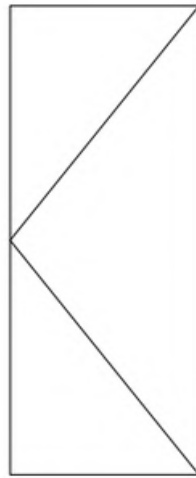
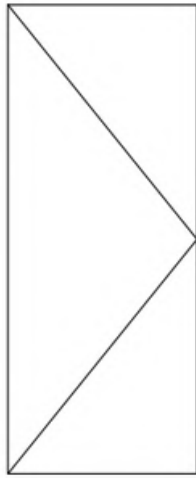
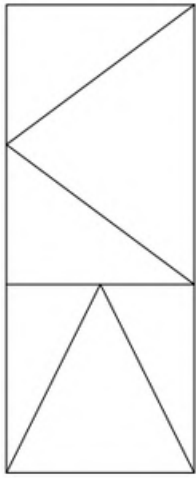
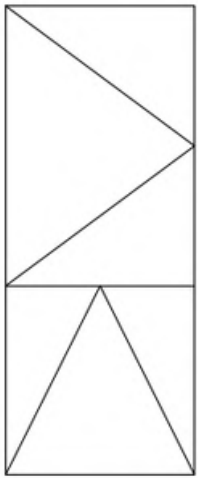

HEIGHT: 1300;1490;1680 mm / **WIDTH:** 585 mm

TALL CABINETS

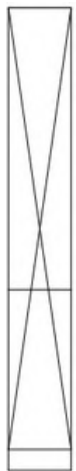

PULL-OUT WITH SYSTEM
WIDTH: 300;400 mm

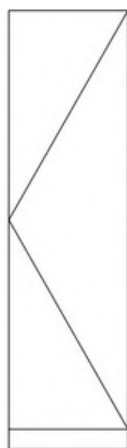
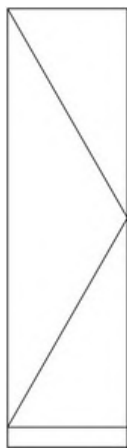

UTILITY CABINET WITH SYSTEM
WIDTH: 600 mm

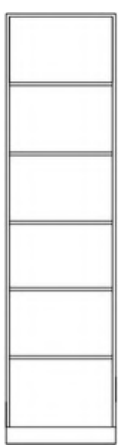
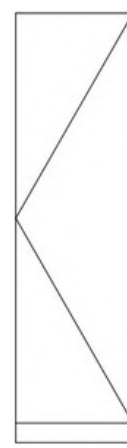

WITH SHELVES AND/OR DRAWERS
WIDTH: 500;600 mm / **HEIGHT:** 2100;2480 mm

CABINETS FOR FRIDGE

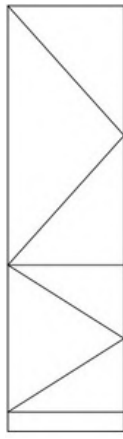
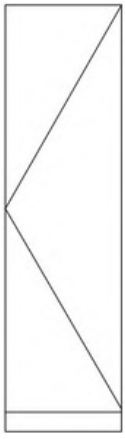

WIDTH: 600 mm / **HEIGHT:** 2100;2290;2480 mm

HEIGHT: 2100;2290;2480 mm

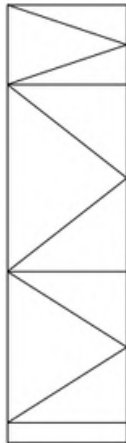
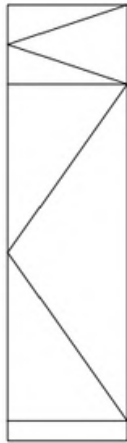
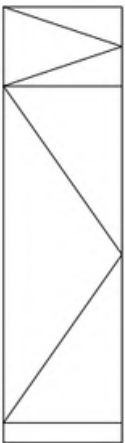

HEIGHT:2100;2290;2480 mm

CABINET FOR OVEN AND BUILT-IN MICROWAVE

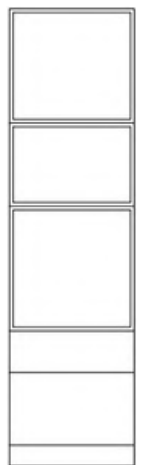
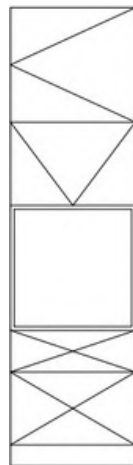
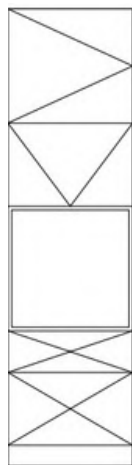
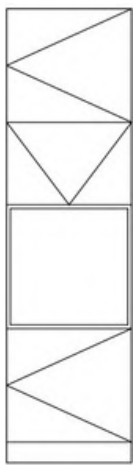
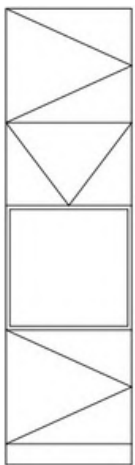

CABINET FOR OVEN

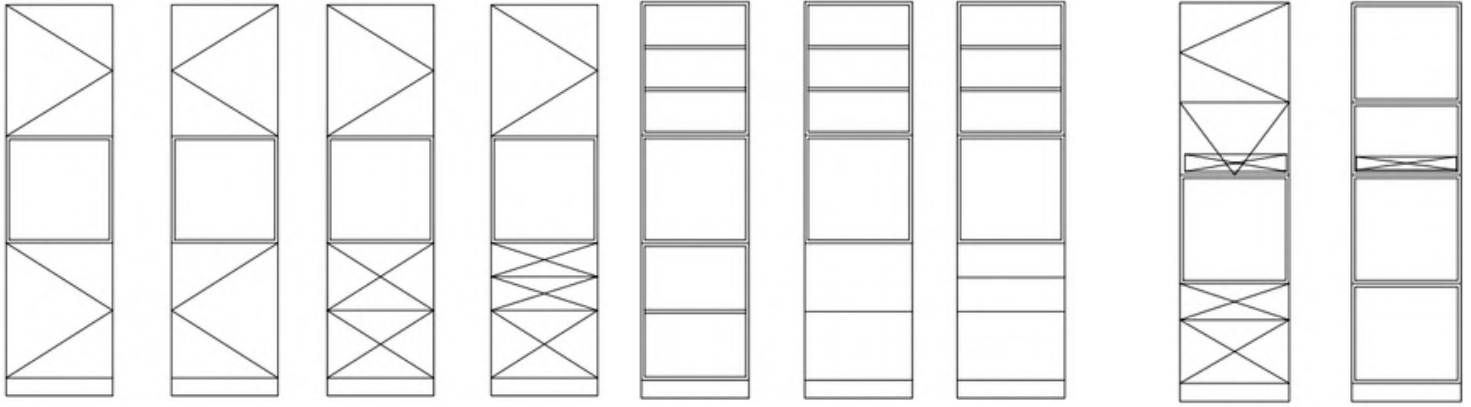

OVEN WITH A COFFEE
MACHINE STATION

CABINET WITH SPACE FOR OVEN AND MICROWAVE OR COFFEE MACHINE

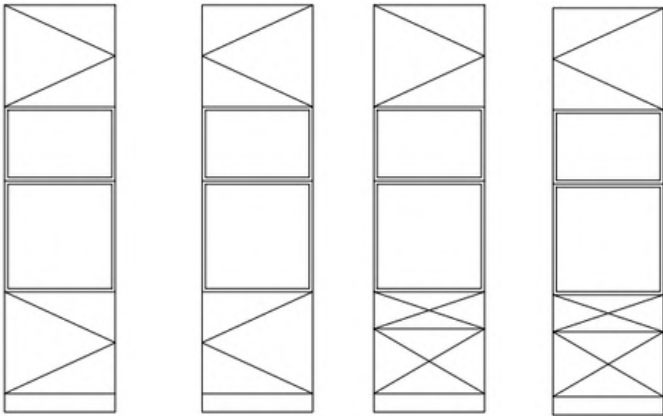

OVEN BELOW THE COUNTERTOP

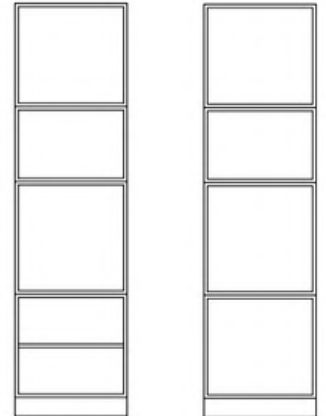

OVEN BELOW THE COUNTERTOP

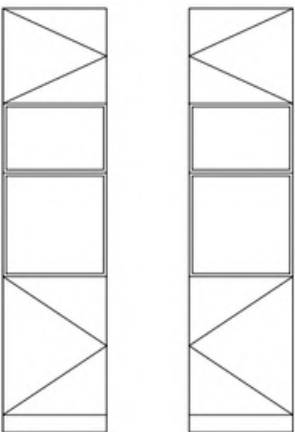

OVEN AT COUNTERTOP LEVEL

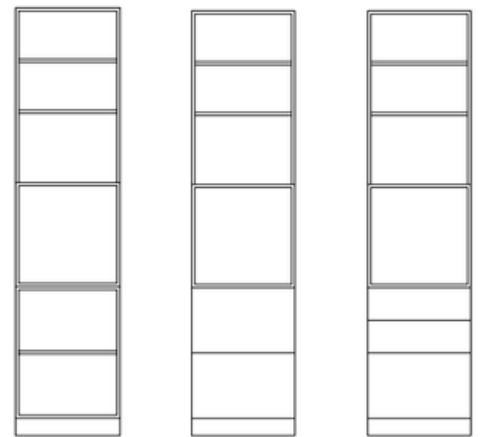

OVEN AT COUNTERTOP LEVEL

CABINET WITH POCKET DOOR SYSTEM

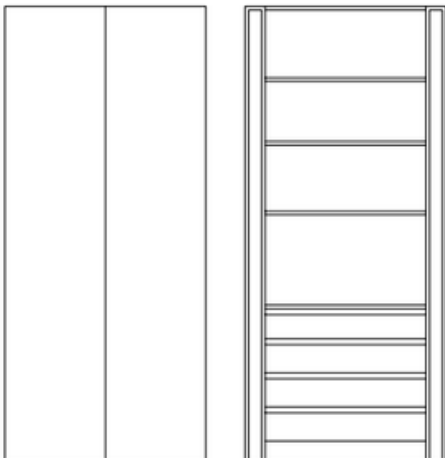

HEIGHT: 2200;2390;2580 mm
WIDHT:1000;1200 mm

MODULES WITH GLASS DOORS AND ALUMINUM FRAME

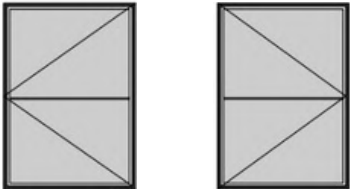

HEIGHT: 570 mm
WIDTH: 300;400;450;500;600 mm

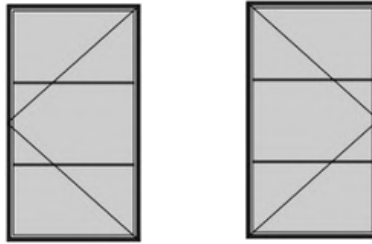

HEIGHT: 760-950 mm
WIDTH: 300;400;450;500;600 mm

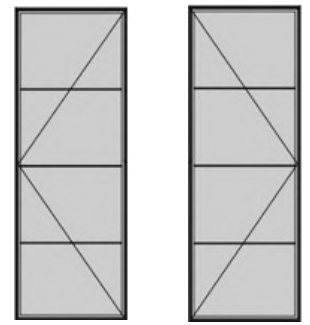

HEIGHT: 1140 mm
WIDTH: 300;400;450;500;600 mm

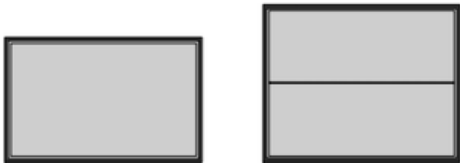

UPPER CABINET
WIDTH: 300;548;600 mm / **DEPTH:** 585;300 mm /
HEIGHT: 380;480 mm

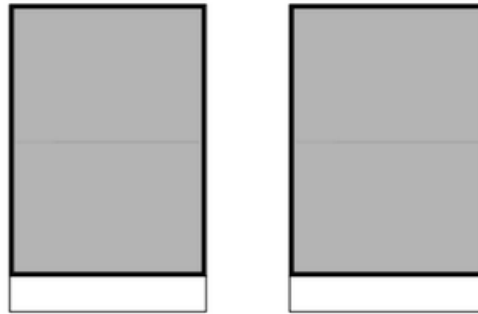

WIDTH: 400;500;600 mm / **DEPTH:** 585;300 mm

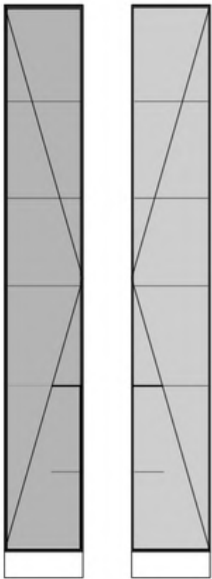

WIDTH: 300 mm

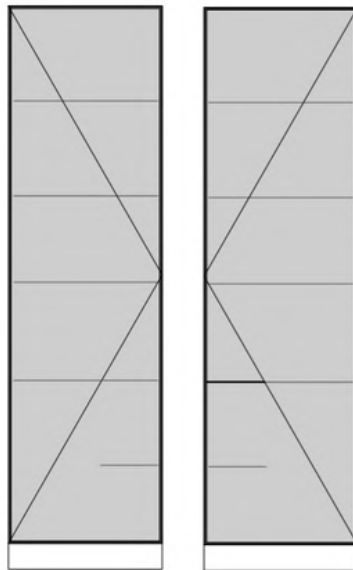

WIDTH: 300;585;600 mm / **DEPTH:** 585;300 mm

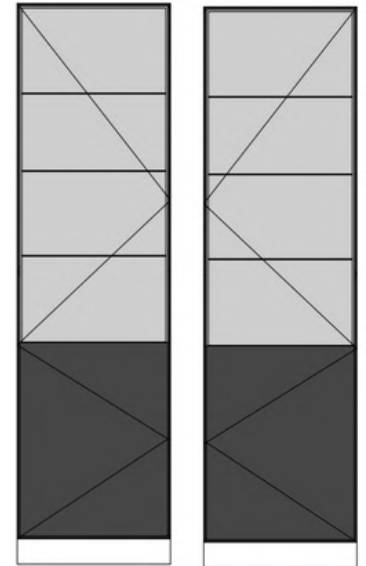

WIDTH: 600 mm



BOOKSHELVES

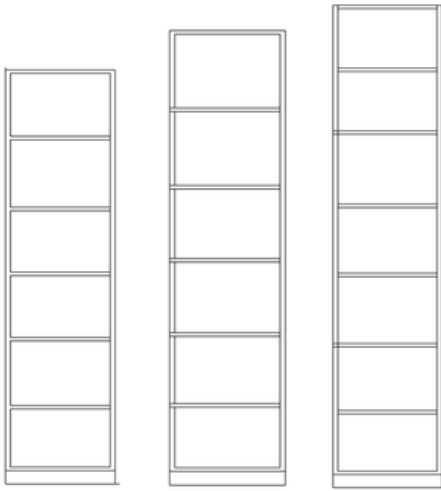

OPEN BOOKSHELVES WITH LED
DEPTH: 300; 585 mm / **WIDTH:** 400; 600 mm
HEIGHT: 2100; 2290; 2480 mm

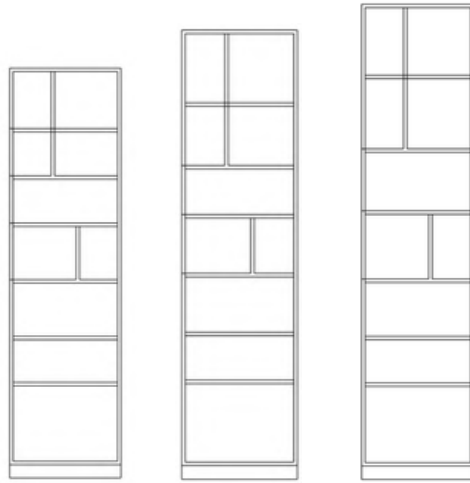

OPEN BOOKSHELVES WITH LED
DEPTH: 300; 585 mm / **WIDTH:** 600 mm
HEIGHT: 2100; 2290; 2480 mm



Drawer unit for desk
DEPTH: 570 mm
WIDTH: 500 mm
HEIGHT: 620 mm



WALL-MOUNTED CONSOLE
DEPTH: 350 mm / **WIDTH:** 450; 800; 900; 1000 mm
HEIGHT: 170 mm

POSSIBLE COMBINATIONS

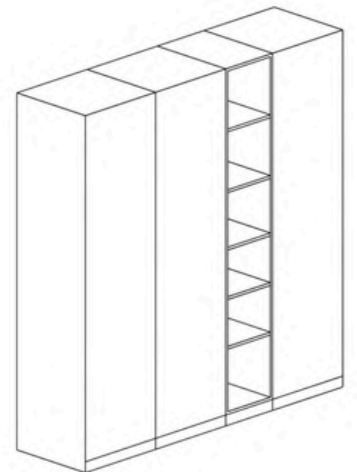
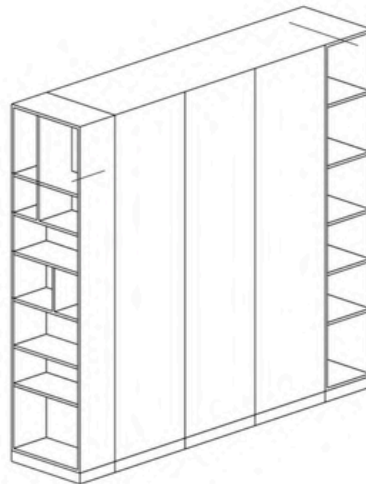
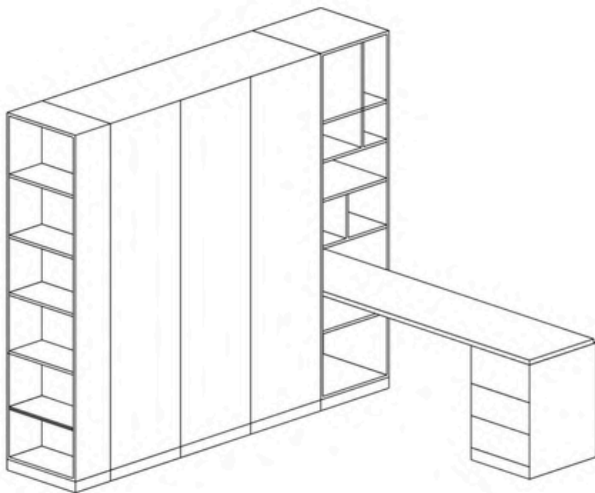

TV UNIT MODULES

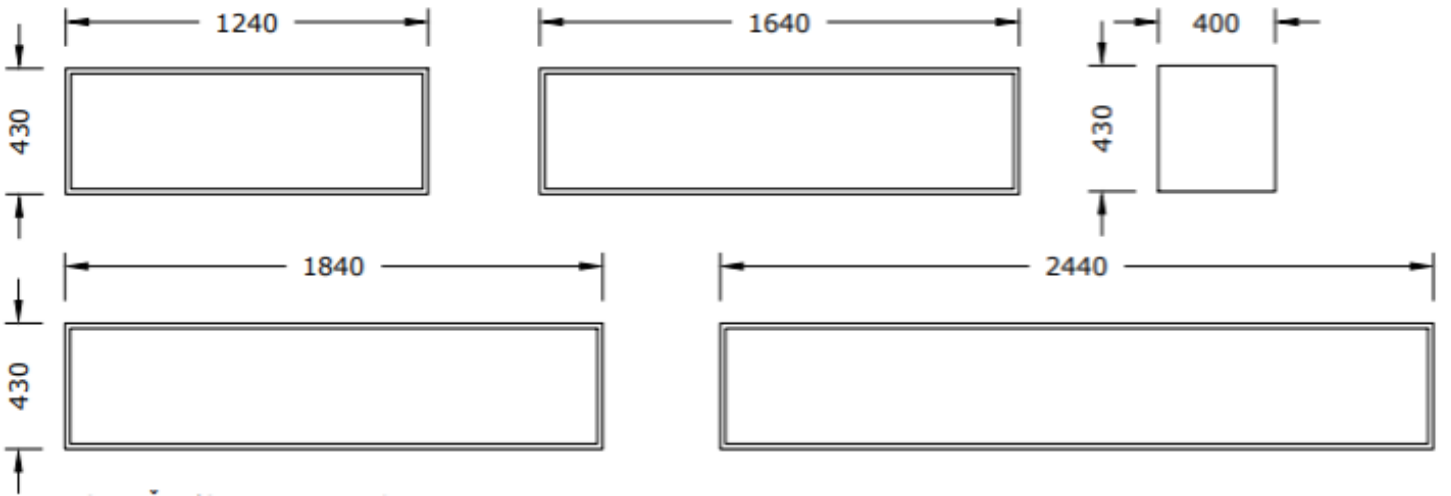

DRAWER / CABINET

TV WALL PANEL WITH LED LIGHTING

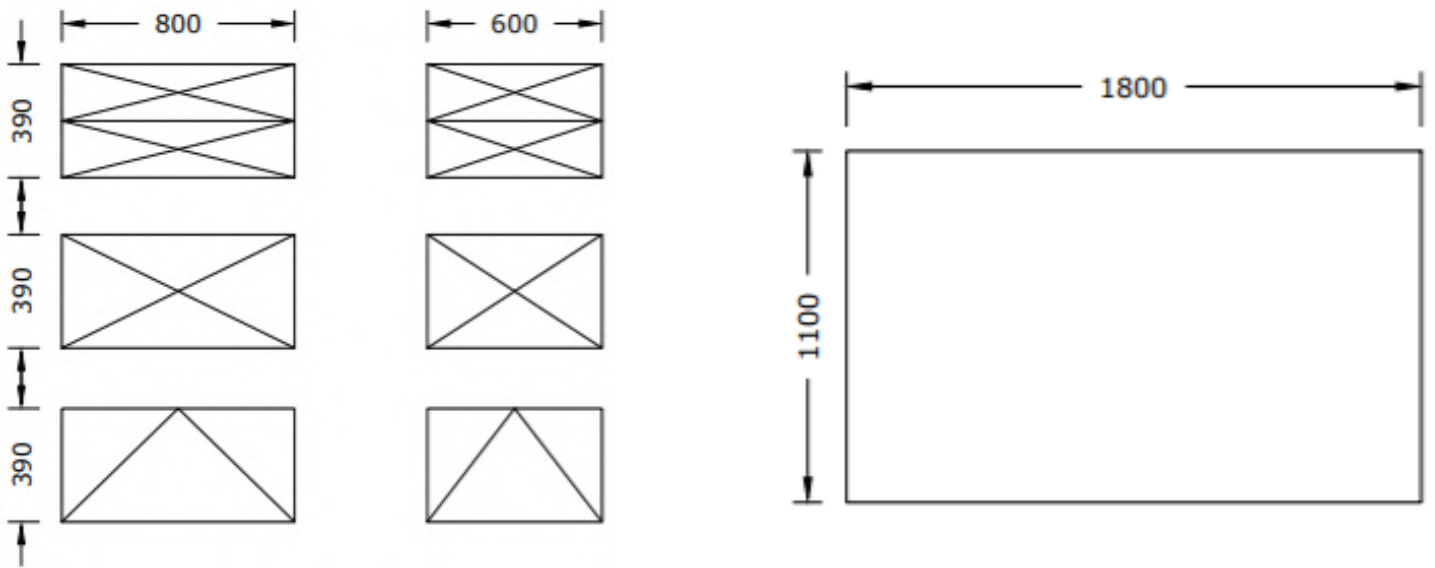

OPEN SHELF

TALL WALL CABINET WITH GLASS DOORS

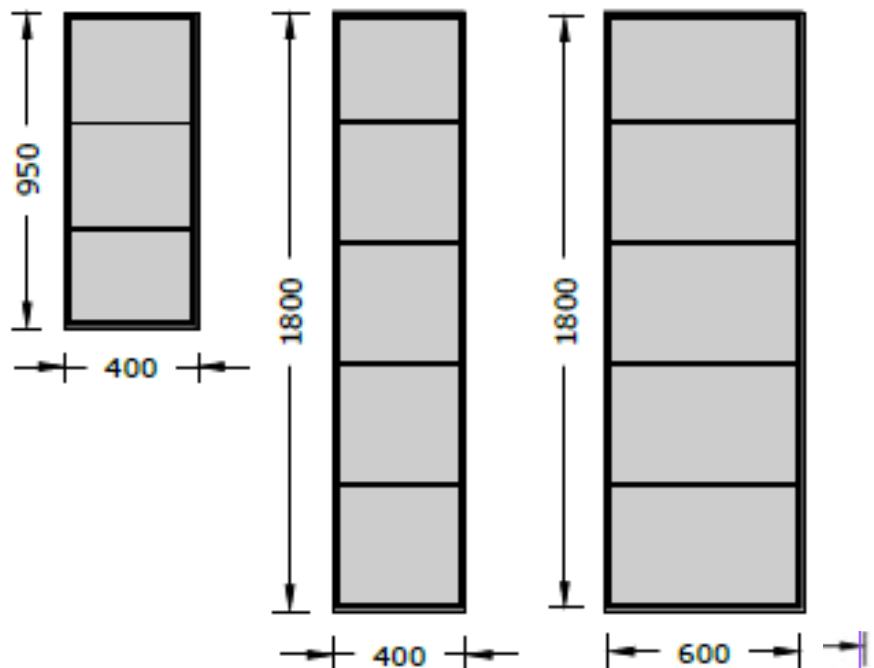
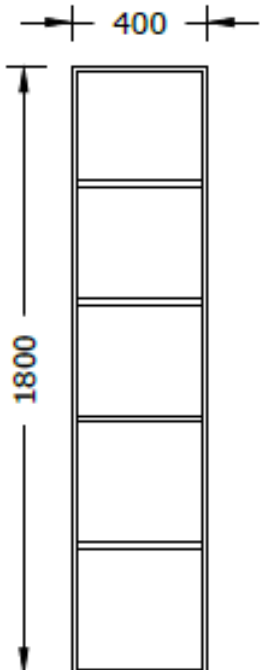

TALL WALL CABINETS

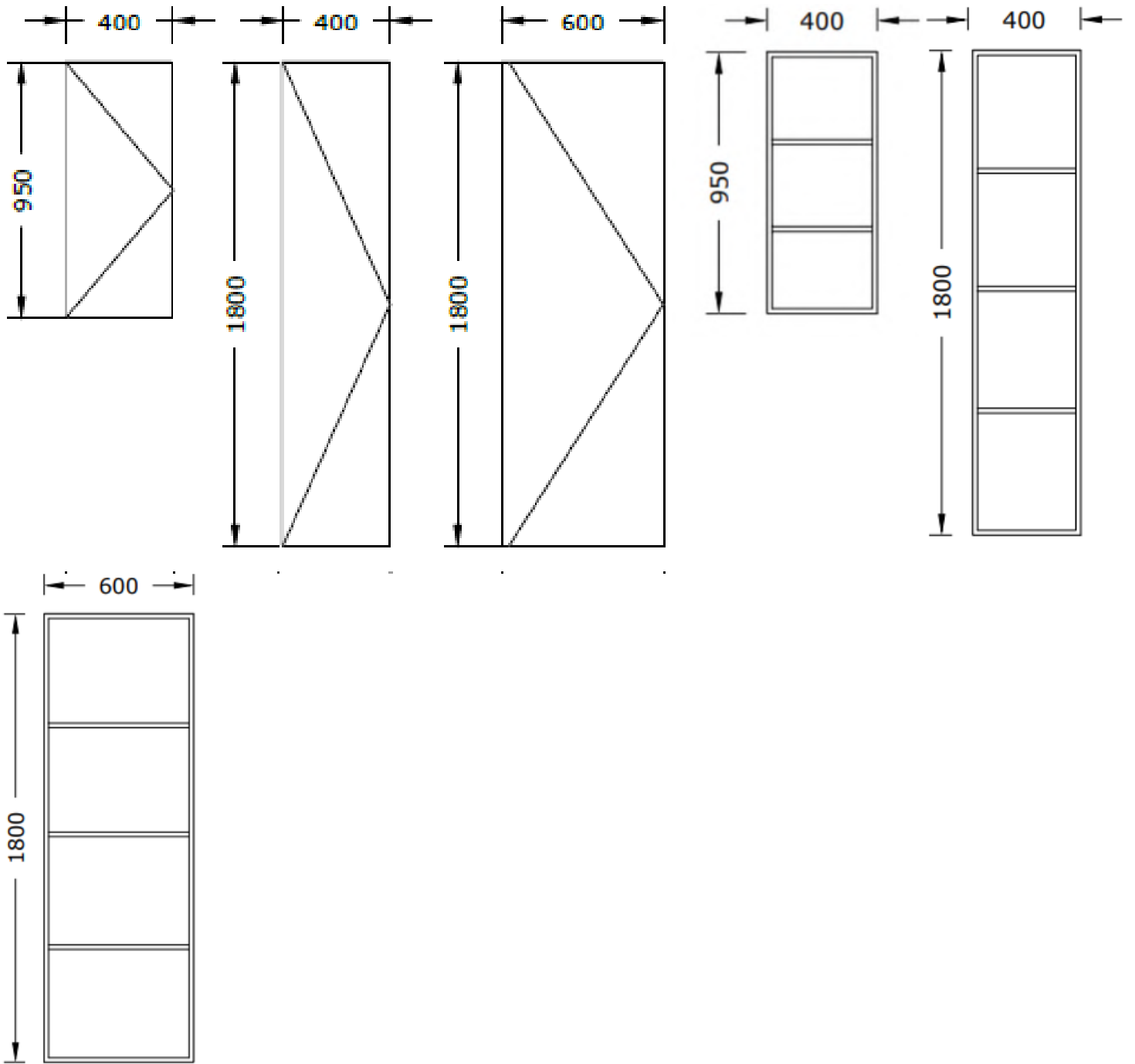

WARDROBE MODULES



OPEN WARDROBES

HEIGHT: 2290 mm / DEPTH: 586 mm



WIDTH: 500;600;700;800;900;1000 mm

WIDTH: 800;900;1000 mm

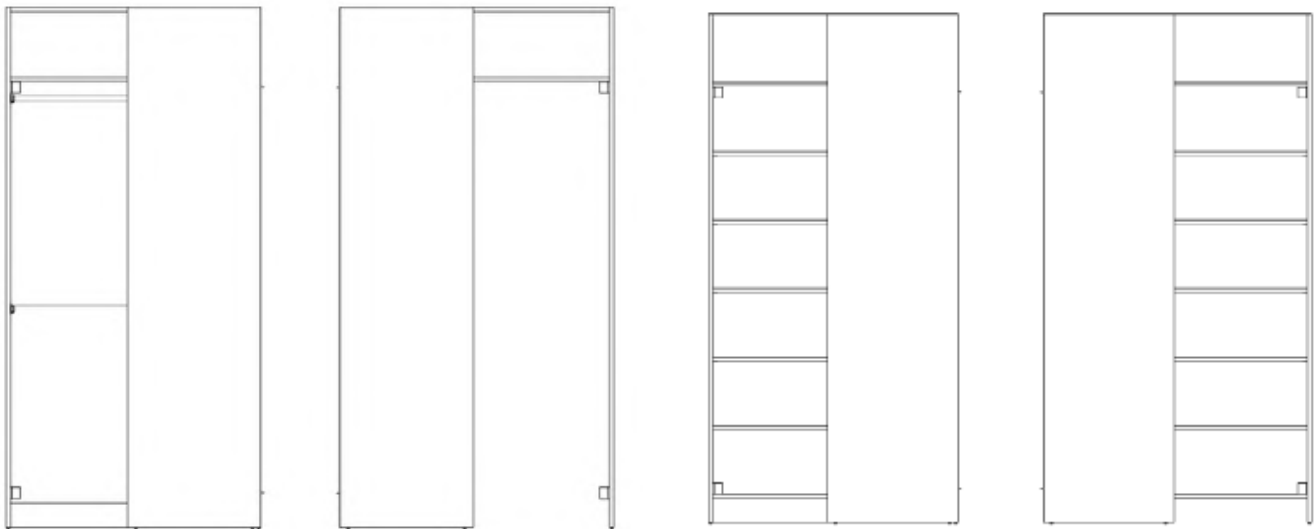

CORNER WARDROBE / SIZE: 1120x1320 mm

CORNER WARDROBE / SIZE: 1120x1320 mm

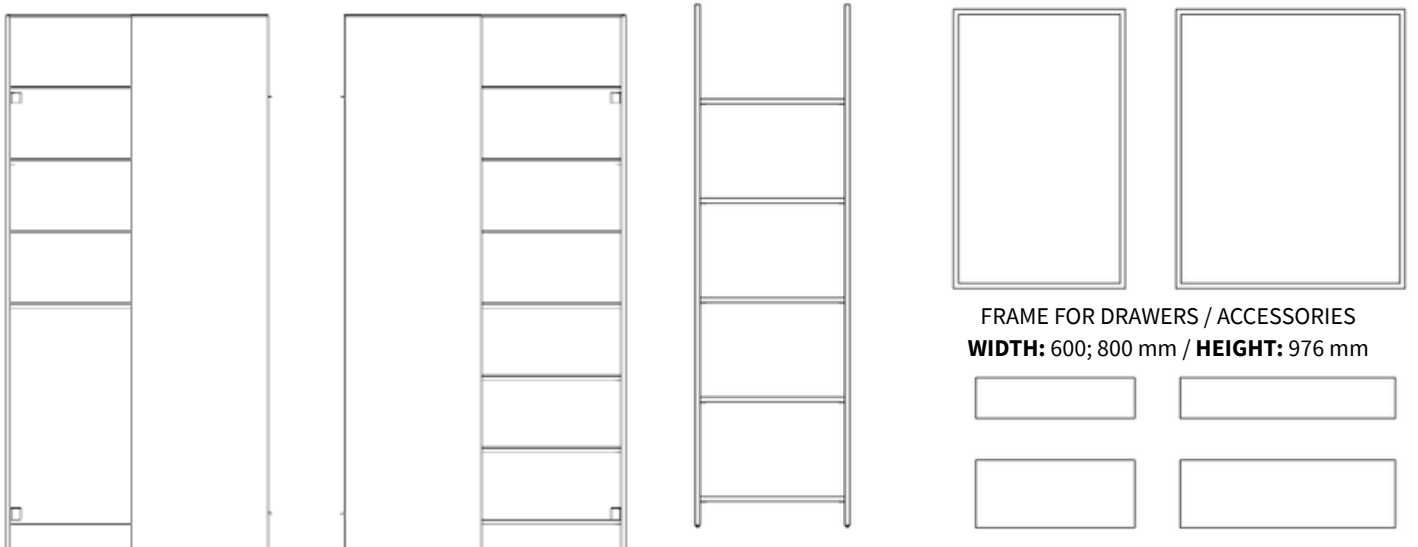

CORNER WARDROBE / SIZE: 1120x1320 mm

ADDITIONAL SHELVES
DEPTH: 290 mm // WIDTH: 600 mm
HEIGHT: 1963 mm

FRAME FOR DRAWERS / ACCESSORIES
WIDTH: 600; 800 mm / HEIGHT: 976 mm

DRAWERS
WIDTH: 464; 564; 664; 764; 864;
964mm / HEIGHT: 145;240 mm

WARDROBES WITH HINGED DOORS

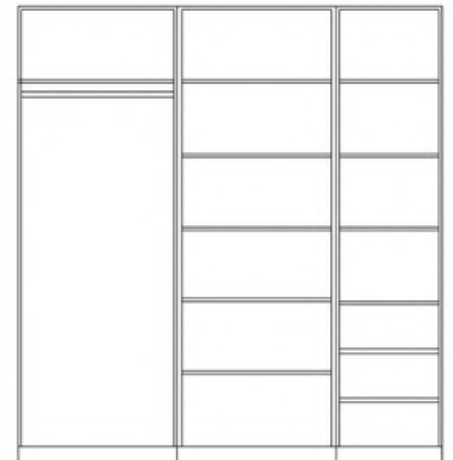
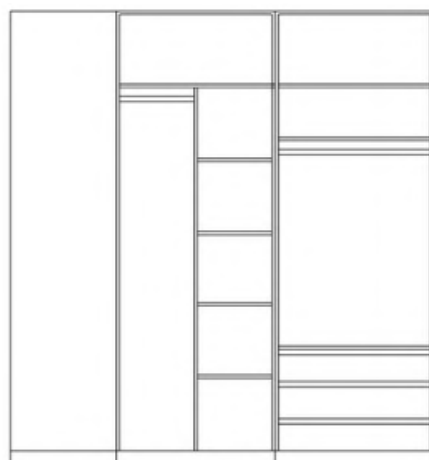
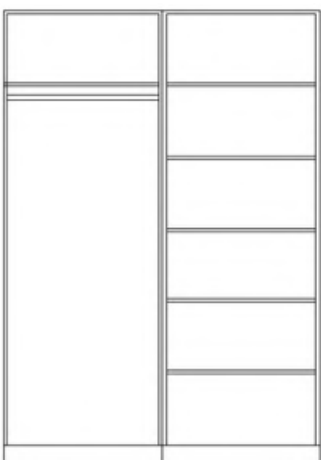
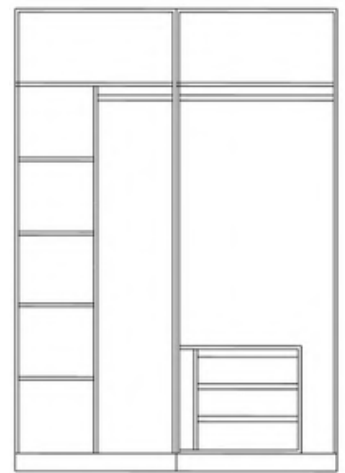
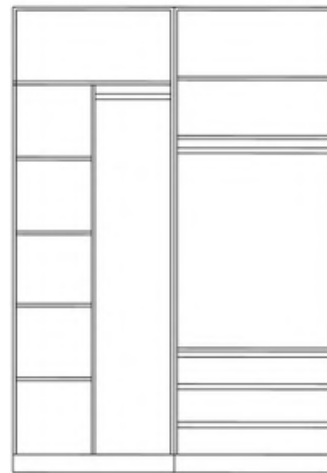
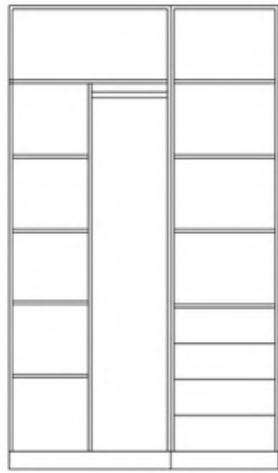
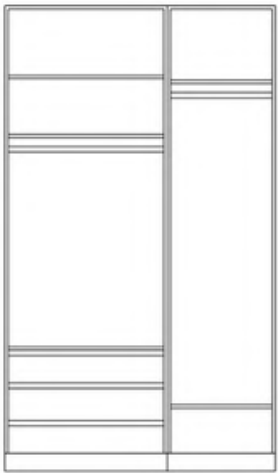
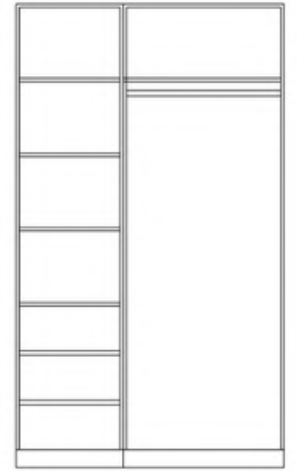
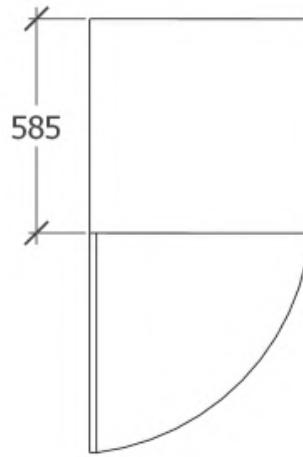
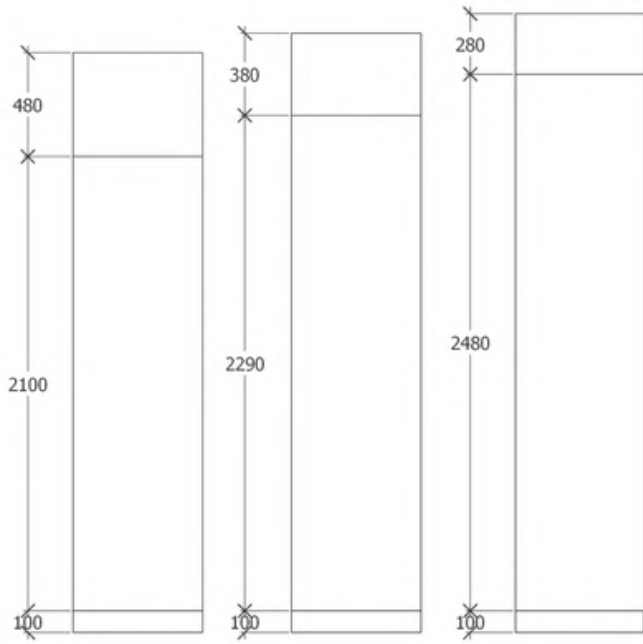

WARDROBES WITH AND WITHOUT LED

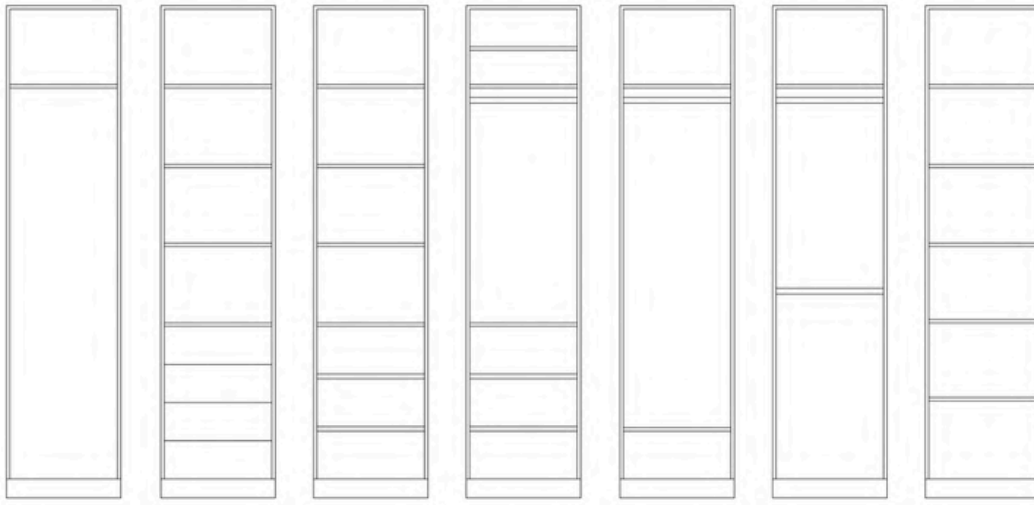

SINGLE-DOOR / **WIDTH:** 500;600 mm

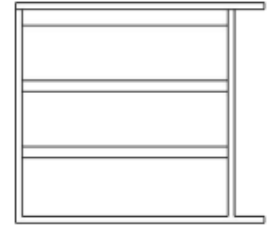

ADDITIONAL DRAWER UNIT
WIDTH: 500 mm
DEPTH: 555 mm / **HEIGHT:** 650 mm

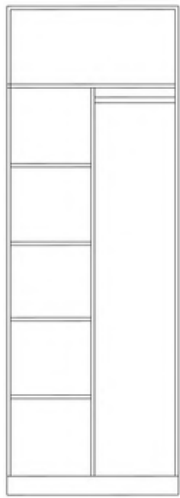

DOUBLE-DOOR
WIDTH: 800; 900 mm



DOUBLE-DOOR / **WIDTH:** 800; 900;1000 mm

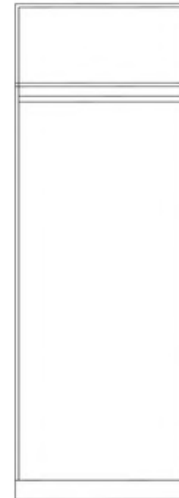

WARDROBES WITH GLASS DOORS

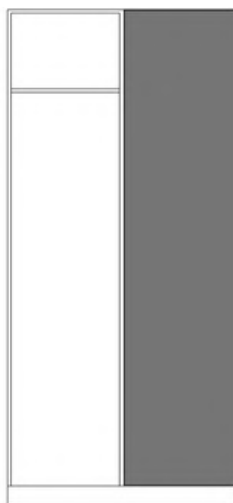
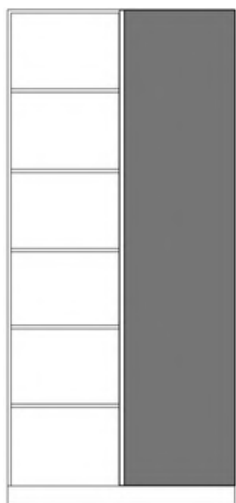

CORNER
WIDTH: 500; 600;1100;1200 mm

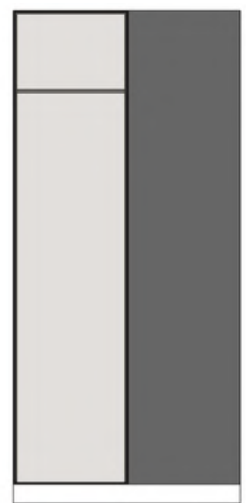

CORNER WARDROBES WITH LED **92**
WIDTH: 500; 600;1100;1200 mm

WARDROBES WITH SINGLE GLAZED DOORS WITH LED

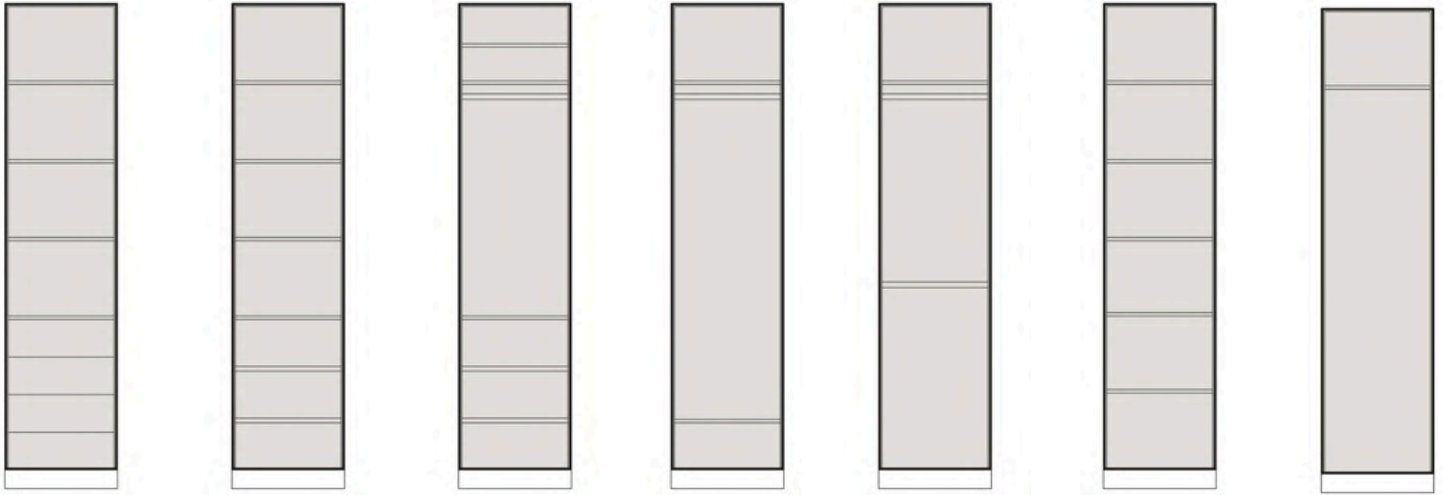

SINGLE-DOOR WITH LED / **WIDTH:** 500; 600 mm



BATHROOM FURNITURE MODULES

HANGING WASHBASIN CABINETS

OPEN WASHBASIN
CABINET



HEIGHT: 380 mm

WIDTH: 200;300;400;450;500;600 mm

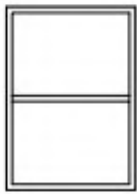

HEIGHT: 570 mm

WITH DRAWERS

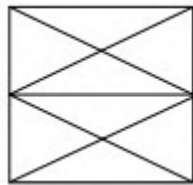

HEIGHT: 570 mm

WIDTH: 600;800;900;1000 mm

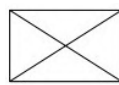

HEIGHT: 380 mm

CABINET WITH DOORS

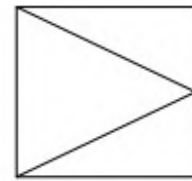

WIDTH: 600 mm

HEIGHT: 570 mm



CABINET WITH DOORS

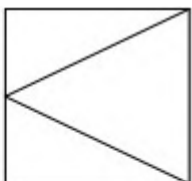

WIDTH: 300-400-500-600 mm

HEIGHT: 570 mm

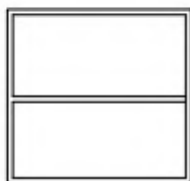

TALL CABINETS WITH DOORS

CABINET FOR THE WASHBASIN

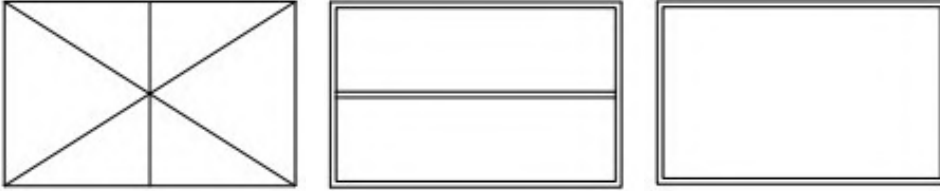

HEIGHT: 570 mm **WIDTH:** 800;900;1000;1200 mm

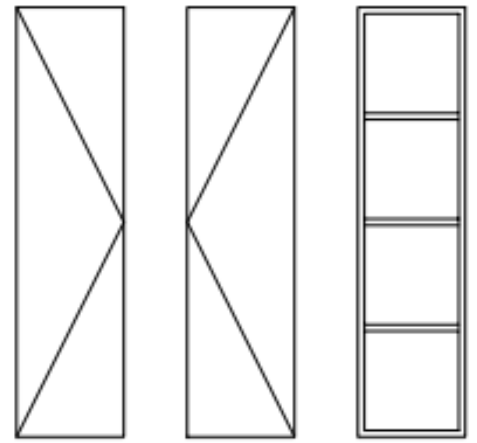

HEIGHT: 1200 mm / **DEPTH:** 250 mm
WIDTH: 300;400 mm

TALL WALL CABINET WITH DOORS

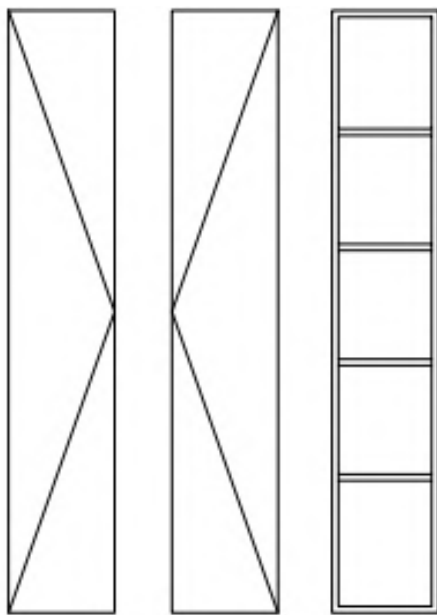

HEIGHT: 1700 mm / **DEPTH:** 250;450 mm

OPEN SHELVES



DEPTH: 120; 140 mm
HEIGHT: 760; 950 mm
WIDTH: 600; 800; 900 1000;1200 mm

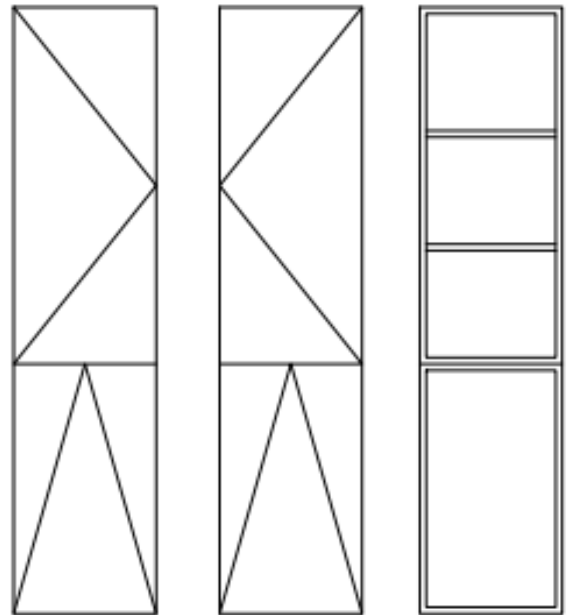

HEIGHT: 1700 mm / **DEPTH:** 450 mm

HANGING MIRROR CABINET WITH DOORS, 140 MM DEPTH

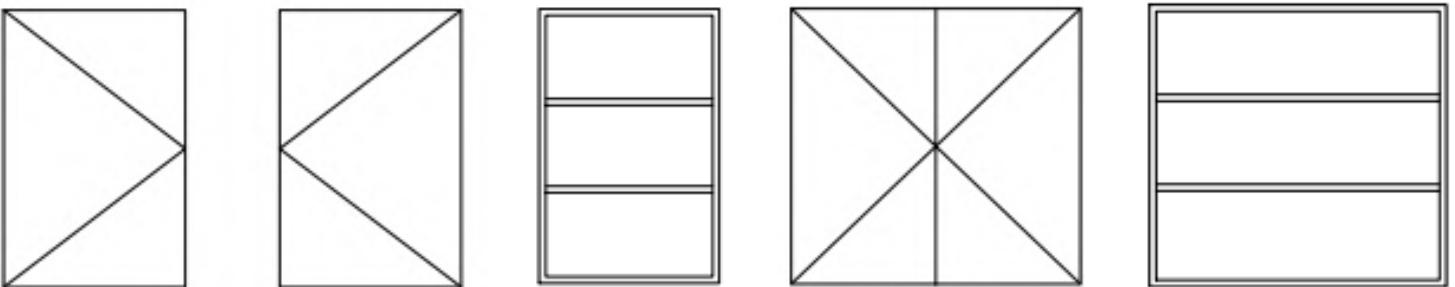

HEIGHT: 760;950 mm / **WIDTH:** 600;800;900;1000;1200 mm

LAUNDRY FURNITURE

CABINET WITH DOORS ABOVE THE WASHING MACHINE / **DEPTH:** 585 mm / **WIDTH:** 625 mm

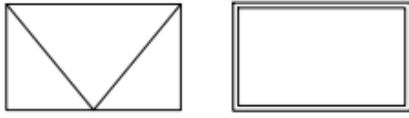

HEIGHT: 280;380;480 mm

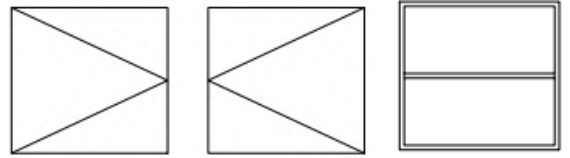

HEIGHT: 480;580;680 mm

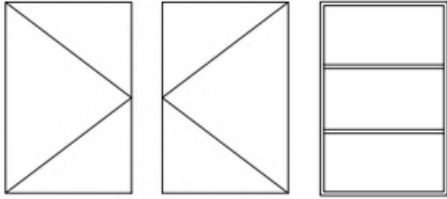

HEIGHT: 760;950 mm

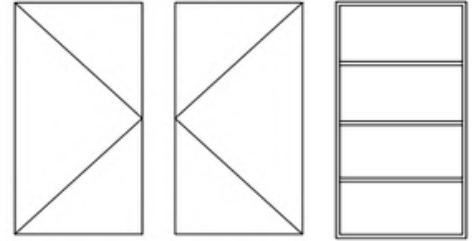

HEIGHT: 1140 mm

WALL-MOUNTED CABINET ABOVE THE TOILET
Different sizes are available

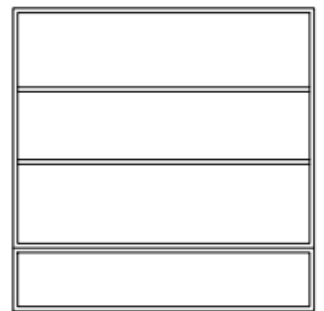
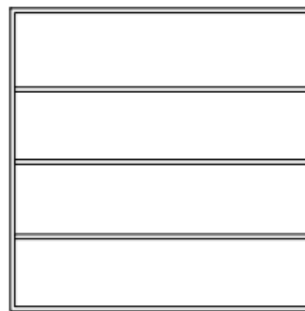
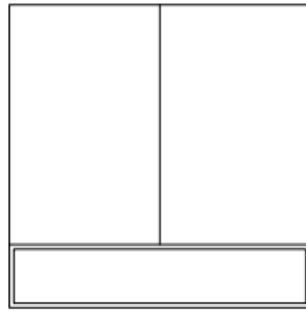
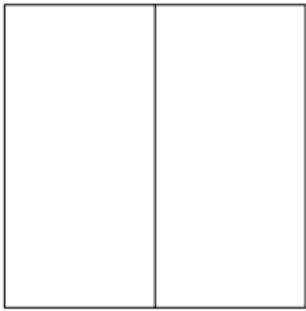

BASE CABINET UNDER THE WASHING MACHINE

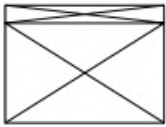

DEPTH: 585 mm / **WIDTH:** 625 mm
HEIGHT: 463 mm

CABINET FOR WASHING MACHINE

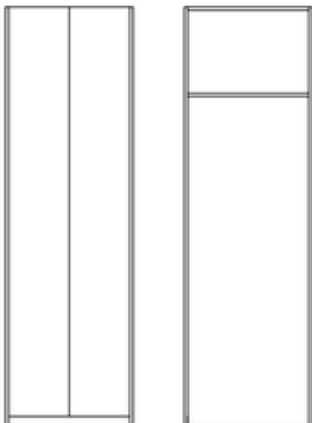

DEPTH: 750 mm / **WIDTH:** 700 mm
HEIGHT: 2100;2290;2480 mm



thank
you

Contacts:



+370 683 75 168



sales@taumona.com



www.taumona.com

